

Pastors and Disasters

A Toolkit for
Community-Based
**Disaster Risk Reduction &
Management** for members and
partners of the Anglican relief
and development community.



In collaboration with



Pastors and Disasters: A Toolkit for Community-Based Disaster Risk Reduction & Management
for members and partners of the Anglican relief and development community.

An initiative of Episcopal Relief & Development with:

Anglican Diocese of Colombo, Sri Lanka
Anglican Church of Burundi
Anglican Episcopal Diocese of El Salvador
Anglican Diocese of Niassa, Mozambique
Church of the Province of Myanmar
Anglican Church of Melanesia
Episcopal Church of South Sudan & Sudan
Anglican Episcopal Church of Brazil
Anglican Board of Mission, Australia
The Amity Foundation, China
Anglican Alliance, United Kingdom

© Copyright 2014 Episcopal Relief & Development. All rights reserved.
A license to print, reproduce, and share these materials is given to those individuals and organizations who wish to use these materials to engage others with the work and mission of Episcopal Relief & Development in healing a hurting world.

Episcopal Relief & Development is pleased to share the Pastors and Disasters Toolkit, a resource manual and workbook of practical tools designed to help improve our efforts to respond more effectively to the increasing severity and frequency of disasters, especially within the context of local Anglican or Episcopal churches and organizations.

The Anglican Communion and its member churches are present in 165 countries and claim membership of 85 million people on six continents. Wherever present, churches respond to disasters before, during and long after. They offer not only spiritual comfort and solidarity, but also sustainability and accountability in any response, including when its own communities and structures are affected. As the world witnesses and experiences the increasing frequency and intensity of natural and human-made disasters, international humanitarian agencies such as Episcopal Relief & Development have seen a growth in the generosity and commitment of our local partners to serve and accompany the recovery of affected communities.

Episcopal Relief & Development primarily works in partnership with local Anglican churches and organizations. In 2010, a comprehensive review of our emergency responses confirmed that in nearly all cases, churches in affected areas responded spontaneously, quickly and instinctively. We also confirmed that many disasters occur regularly. Some areas are continually prone to drought; others experience annual typhoons and monsoon flooding. In such places, there is much that can be done to prepare for and mitigate the impact of these inevitable events. The analysis revealed specific opportunities for churches to build on their experiences and formalize good practices that are congruent with international standards. Thus, our churches can elevate their ability to serve communities more effectively and leverage new response partners and resources.

We convened a global Disaster Risk Reduction and Disaster Management Working Group to collaborate on creating these tools. Twelve partner representatives joined us from Australia, Brazil, Burundi, China, El Salvador, Mozambique, Myanmar, the Solomon Islands, South Sudan, Sri Lanka, the United Kingdom and the United States of America. We are enormously grateful for their contributions and generosity.

For over two years, the working group adapted, developed and field tested user-friendly tools that can be used in both low- and high-capacity contexts. The tools are especially suited to the Anglican context, and are designed to build on our existing human, technical and structural assets and resources – thereby heightening awareness of available networks and improving monitoring mechanisms that enhance and increase local capacity. We drew on a wealth of existing materials, which are identified as references.

The Pastors and Disasters Toolkit is open-sourced, thus permitting its use to anyone interested in equipping service organizations to prepare for, mitigate and respond to disasters efficiently and effectively.

We invite you to share these resources and to share your comments and experiences with us.

Kirsten Laursen Muth
Senior Director
International Programs
Episcopal Relief & Development

Nagulan Nesiah
Interim Senior Program Officer
International Emergency Response Coordination
Episcopal Relief & Development

How to use the Toolkit

The Toolkit is divided into six sections:

Anglican Theological Perspectives

Terms & Definitions

Core Competencies

The technical content of the Toolkit is divided into four Core Competencies. The skills, knowledge and know-how represented in these four competencies demonstrate advanced capacity in Disaster Risk Reduction and Management. Attaining fluency in these four Core Competencies demonstrates fluency in Disaster Risk Reduction:

- **Community Mobilization**
- **Risk Assessment**
- **Disaster Risk Reduction (DRR) Implementation**
- **Disaster Response**

Capacity Assessment Worksheet

Eight Standards articulate specific thematic areas within the four competencies. Each Standard has three levels: **beginning, intermediate and advanced** – designed with the aim that the user will attain the most advanced stage of each Standard by using this Toolkit.

Tools

Each of the 24 Tools provides ideas, instructions, guides and information for Disaster Risk Reduction.

Case Studies

References

Table of Contents

Section 1	Anglican Theological Reflections	1.0
	Episcopal Anglican Diocese of El Salvador	1.1
	Diocese of Colombo, Church of Ceylon, Sri Lanka	1.2
	Anglican Church of Burundi	1.4
Section 2	Terms & Definitions	2.0
Section 3	Core Competencies	3.0
	Core Competency 1: Community Mobilization	3.1
	Core Competency 2: Risk Assessment	3.2
	Core Competency 3: Disaster Risk Reduction Implementation	3.4
	Core Competency 4: Disaster Response	3.5
Section 4	Capacity Assessment Worksheet	4.0
Section 5	Tools	5.0
	Tool 1: Serving the Wider Community	5.1
	Tool 2: Workshop for Community or Parish Leaders	5.3
	Tool 3: Workshop for Church Leadership	5.5
	Tool 4: Committee Roles & Responsibilities	5.7
	Tool 5: Developing a Committee Work Plan	5.9
	Tool 6: Disaster Coordinator Job Description	5.11
	Tool 7: Basic Mapping Exercises	5.13
	Tool 8: Comprehensive Mapping Exercises	5.17
	Tool 9: Prioritizing Activities	5.21
	Tool 10: Early Warning System	5.25
	Tool 11: Communication System	5.27
	Tool 12: Evacuation Centers	5.29
	Tool 13: Community Drills	5.31
	Tool 14: Household Preparedness Kits	5.33
	Tool 15: Managing Volunteers	5.35
	Tool 16: Risk Reduction Programming	5.37
	Tool 17: DRR Indicators	5.39
	Tool 18: Relief Assessment Format	5.41
	Tool 19: Recovery Assessment Format	5.43
	Tool 20: Core Principles	5.47
	Tool 21: Thematic Tip Sheets	5.49
	Tool 22: Risk Reduction in Disaster Relief & Recovery	5.53
	Tool 23: Staff Care Policy	5.55
	Tool 24: Recognizing and Managing Stress	5.57
Section 6	Case Studies	6.0
	References	

SECTION 1:

Anglican Theological Reflections

A Theological Reflection on Risk Management

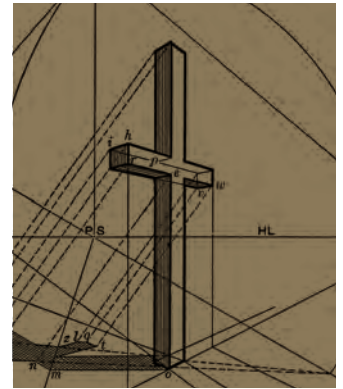

“Everyone then who hears these words of mine and acts on them will be like a wise man who built his house on rock.” Matthew 7:24

The Bible is the sacred book that inspires us to interpret the events that affect us in our lives. The Bible is not a scientific book, but serves as a guide for our understanding that God is the master of life. That is why we as churches are not only strengthened by reading the Word of God, but it calls us to apply its teachings in our daily lives and offer scientists guidelines for reflection.

This brings to mind the primary and secondary laws of ecology: everything is related to everything else, and everything goes somewhere – principles established by the following:

We understand that on one hand we must be attentive to research and prepare in advance to deal with any type of disaster; organize so that we can appropriately manage available resources and develop additional resources – for the purposes not only of defending life, but also becoming more creative ourselves.

If we understand the laws of ecology, everything is related to life and renewable resources on earth. From the biblical perspective, what we are asked as churches is to carry out a diaconal ministry so that we can be an example of service in meeting human needs and also offering resources to scientists for more high quality research.

As churches we must prepare to respond to and prevent natural disasters. Noah is an example of this preparation. Noah was a person both ancient and with contemporary relevance, especially now with the threat of climate change to God’s creation.

Regarding the biblical texts of Luke and Matthew: they specifically explain how we should prepare ourselves and how we should serve as good deacons in risk management. But I would also reference Noah in Genesis chapter 6, verses 9-22. Here we are given clear examples of how we should prepare to respond to different disasters, creating the conditions within the community and preparing all the resources we have for a strong risk mitigation plan. Surely we will receive the great blessing of God.

The Rt. Rev. Martin Barahona

Bishop, Episcopal Anglican Diocese of El Salvador

A Theological Reflection on Disaster Response

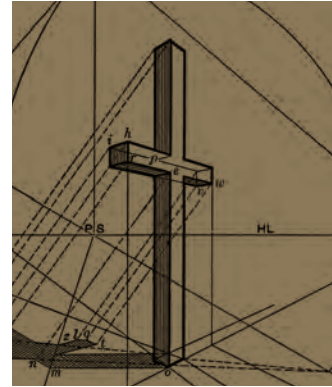

People of all communities in all nations face disasters from time to time. When we have a look back at the history of the world, we can identify many such disasters from time immemorial. With the huge development of mass communications in the late 20th century, scenes of disasters, even in the remotest corners of the world, are instantaneously brought into people's homes today.

Humans have tried to cope in various ways when faced with such disaster situations. The instinct to provide some immediate relief is a spontaneous reaction. There is hardly any time to engage in assessing the real needs of the victims. Whatever is available is given to assist them. From here, one moves to a much more organized relief and rehabilitation effort, followed by development and advocacy work.

This type of organized response needs careful planning, assessment of real needs, taking into account relief delivery capacity, interventions and negotiations. If communities are equipped beforehand and systems are in place, then all humanitarian work carried out will be of quality and will preserve the dignity of the victims.

Often, human responses to disasters are emotional if the communities are not prepared in disaster mitigation and management. Emotional responses will meet only part of the immediate needs, but will not assist the persons to transform their lives and communities.

When the tsunami waves struck Asia on December 26, 2004, around 40,000 lives were lost in my country, Sri Lanka alone. There was chaos all over. People lost their lives, belongings and property. Infrastructure was destroyed. Many places of religious worship opened their premises to Internally Displaced Persons (IDPs). In one instance, I recall, residents of a town close to Colombo donated dinner packets to feed the displaced on December 26, but it was in excess. The organizers took the excess dinner packets to another town situated about 30 kilometers away where another group of displaced were housed. After feeding the IDPs in that town also there was excess food and that food was buried. Sri Lanka also lost a golden opportunity to rebuild the country. Had there been strategic planning and coordination, there is no doubt that the country would have been rebuilt quicker and better

What lessons can be drawn from the response mentioned above for future disaster responses?

The Book of Nehemiah refers to the rebuilding of the walls of Jerusalem after being destroyed by the enemy. People too were taken into captivity. The people lost their dignity. Nehemiah was one of those captives. After some time, Nehemiah had a desire to rebuild Jerusalem. He informed the king of his intention. The king gave his consent as well as material assistance. However, Nehemiah realized that the greatest asset he had for the task was human resources, and without people rebuilding was impossible.

Deuteronomy 32:9 reads, “For the Lord’s portion is his people”. Participants in disaster responses, relief, rehabilitation, development and advocacy usually fall into two categories. There are the givers and the recipients. Generally, there are more receivers than givers. If the recipients are transformed to be co-workers, then human resources increase. When that happens the recipients no longer remain as observers, but instead become active participants. The disparity between the giver and recipient reduces. The recipients then play a major role in the rebuilding of their lives, communities and nation.

A soccer player in a school represented the country in a youth tournament. He had excellent skills in ball passing and in scoring goals. The rest of the members of his team depended too much on this player and used to pass the ball to him expecting him to win matches for the team all the time. When the opponents noticed what the team members were doing, they marked this player with two or three of their own. The result was obvious; he couldn’t win matches all by himself. After a few matches, the coach realized what was happening and concentrated on improving the skills of other players as well. That brought dividends. Delegation, sharing of responsibilities and equipping people are important for achievement and to reach goals and ideals.

One day, Jethro, Moses’ father-in-law, visited Moses. Jethro watched Moses from a distance counseling the people from morning till evening. The people waited for their turn to share their problems. Jethro realized that both Moses and the people would be worn out soon and advised Moses to appoint leaders over small groups and empower them to hear the cases. He further advised Moses to hear only those cases that others couldn’t handle (Exodus 18). There was recognition and empowerment of the people. They were tasked with responsibilities to become effective and to make a difference.

The Good Samaritan story challenges us to transcend creed and ethnicity in disaster responses and humanitarian work (Luke 10:25-37). Thasinthan, a 17-year-old boy from Shanthapuram from Wannu in the Northern part of Sri Lanka lost both his parents during the final stages of the war in Northern Sri Lanka. Thasinthan came under the care of an aunt who supported him while he tried to rebuild his life and those of his three younger siblings. Thasinthan could not pass his school public examination in 2010 at the first sitting. He attended day classes to sit again. He is also fond of cricket and plays cricket after school. He was determined to overcome the traumatic experiences he and his brothers underwent. The members of the Board of Social Responsibilities of the Diocese of Colombo met this young boy when they engaged in a Needs Assessment Survey to identify persons to conduct a livelihood assistance programme for returning IDPs.

This boy appealed for assistance to purchase some equipment for cultivation of the land. A small-built boy of 17 years was not considered to be a suitable recipient as he didn’t fulfill the selection criteria. But the community insisted and he was included as a recipient under special circumstances. His aunt took a loan and bought a small plot of land to put up a shelter for this boy, and to help him cultivate. The boy cultivated the land and with the earnings he slowly started paying back this loan, his tuition fees and he also supported his brothers. A caring community can empower people to stand on their own feet with self-respect and dignity and also contribute to the welfare of others.

Nehemiah trusted the people. Moses listened to his father-in-law Jethro who was from a different religious persuasion. The community supported Thasinthan and he in turn supported his family. In multi-religious societies, Christians should have the humility to work with people of sister faiths and those of no faith and learn from their experiences and sacred texts. The primary objective of disaster response is to transform individuals and communities.

The Rev. Dr. Jayasiri T. Peiris

Past Chairperson, the Board of Social Responsibility

Past General Secretary, the National Christian Council of Sri Lanka

A Theological Reflection on Disaster Preparedness

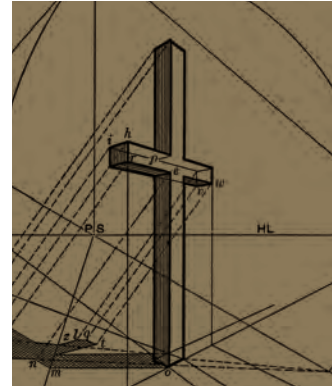

“The seven years of plenty that prevailed in the land of Egypt came to an end; and the seven years of famine began to come, just as Joseph had said. There was famine in every country, but throughout the land of Egypt there was bread.” (Genesis 41:53-54)

After the creation of heaven and earth and all the creatures including the human being, God said that it was good and His love continued to be extended to His creation to the extent that He promised with the sign of the rainbow that He will never destroy what He has created by waters (Genesis 9:12-13).

The mission given by God to humans was to have dominion by maintaining harmony within the created order.

God has been faithful to His promises, but human beings have not held to those promises and could not follow what God had asked them, to care for the whole creation as good stewards. Thank God that He kept loving and looking after Adam (Genesis 3:9) – and us!

Disaster preparedness is an ideal for everyone who loves the Lord and His creation and it is important that people of God – the Church of Christ – should take note that it is our responsibility to keep that relationship with God the Creator and take care of what He has created.

This theological reflection taken from Genesis 41:25-28 therefore shows how our Creator, our Savior God, is love:

1. God shows His love for creation:

God showed His love and care by giving Pharaoh the warning in a dream to save Egypt and all the surrounding countries from hunger. This disaster could have happened without warning, but the Love of God put the dreams not just into any person, but into the Pharaoh, who had the power and ability to take action.

2. Pharaoh shows responsibility:

Pharaoh responds by persisting in finding out the meaning of the dream (Genesis 41:25-31) and choosing Joseph to become the steward of that huge DRR project for the Egyptian people (Genesis 41:40-44).

3. Joseph shows a good example:

Joseph became an important figure, not only in being a good manager, but also for being a very good example showing love, forgiveness and reconciliation with his brothers who had sold him when he said, “Come closer to me... I am your brother, Joseph, whom you sold into Egypt. And now do not be distressed, or angry with yourselves... for God sent me before you to preserve life.” (Genesis 45:4-5)



The role of the Church today in order to take care of God's creation – humanity – as Joseph did is:

- Praying for and receiving God's inspiration so that people in the position of taking actions can understand what God wants them to do.
- Accepting the responsibility to be the messengers/ambassadors of the community to respond to risk and disasters at the right time in the right way.
- Building resilience by strengthening governance, accountability and partnership.
- Being prepared in disaster (before, during and after) and showing our love as God did and continues to do.
- Including everyone in contributing to the sustainability of the environment.

There is only one instrument for sustaining God's creation – humanity. To raise the awareness of everyone requires moral leadership, and this is the mission of the Church together with other concerned organizations, i.e., the United Nations. The Anglican Communion must engage with other agencies with sound knowledge and experience to impact church members, various levels of government and the business communities to take action. **Now is the time.**

The Most Rev. Bernard Ntahoturi

Archbishop, Anglican Church of Burundi

SECTION 2:

Terms & Definitions

CAPACITIES: the resources and skills people possess, can develop, gather, use and access, which allow them to cope with disaster risk and have more control over shaping their own future.

COMMUNITY MOBILIZING: the ability to engage with community and church leaders in all phases of programming.

COMPETENCIES: the abilities to do something successfully or efficiently.

DISASTER: the situation when a hazard affects people who are in a vulnerable situation and who are unable to cope with the impact of the hazard.

DISASTER MANAGEMENT: all aspects of preparation and response to disasters, including before, during and after the hazard incident.

DISASTER PREPAREDNESS: to prepare for, predict and respond to the expected impact of a hazard.

DISASTER RESPONSE: the ability to have a method for providing relief in the short term, and assisting with recovery and rehabilitation needs, including activities for risk reduction.

DISASTER RISK: the potential disaster losses in lives, health, livelihoods, assets and services, which could occur in a community if a hazard was to strike.

DISASTER RISK REDUCTION: the practice of reducing disaster risks through regular analysis and management of the factors that could cause a disaster. For example, reducing exposure to hazards, lessening the vulnerability of people and property, safely managing land and the environment and improving preparedness.

DISASTER RISK REDUCTION PLAN: a program of activities making good use of existing assets and reducing risks with identified outcomes, timeline and budget.

EARLY WARNING SYSTEM: the system needed to generate and distribute timely and clear hazard warning information to help individuals, communities and organizations to prepare and to act appropriately with enough time to reduce harm or loss.

HAZARD: an event, natural object or situation, which has the potential to cause disruption or damage to infrastructure and services, people, their property and their environment.

MITIGATION: lessening, reducing or avoiding harmful impacts of a disaster by various means, such as planting trees and building or enhancing better shelters, embankments, drains, canals, etc.

MONITORING: the process of checking programs and work plans regularly to make sure that they are helping to reach objectives.

PREPAREDNESS: activities designed by the community to face, absorb and recover from a disaster.

PREVENTION: see Mitigation.

PROTECTION: activities designed to safeguard people, particularly vulnerable and marginalized individuals and groups, during disasters, and ensure their equal access to services and resources.

RECOVERY: the restoring and improvement of facilities, livelihoods and living conditions of disaster-affected communities, designed to reduce disaster risk and apply the “build back better” concept to help the community to cope better with any future disasters.

RESILIENCE: the ability of a community or society exposed to hazards to resist, absorb, adjust to and recover from the effects of a hazard in a timely and efficient manner.

RISK ASSESSMENT: the ability to analyze the risks hazards pose to a community with special attention provided to vulnerabilities and capacities.

RISK: the probability that negative consequences may arise when hazards interact with vulnerable areas, people, property and the environment. Also see Disaster Risk.

STANDARD: a level of quality.

STAKEHOLDERS: individuals or groups who are impacted or directly involved in an activity.

TOOL: a format, instrument or instruction used to accomplish a particular task.

VULNERABILITY: the state which reduces the ability of a community to prepare for and cope with the impact of hazards due to their economic, social, physical or geographical situation.

References: Abarquez I and Murshed Z (2004). *Field Practitioner's Handbook*, Asian Disaster Preparedness Center.

Venton P and Hansford R (2006). *ROOTS 9: Reducing risk of disaster in our communities*, Tearfund.

SECTION 3:

Core Competencies

Disaster Risk Reduction & Management

The technical content of the Toolkit is divided into four subjects or themes that we call “Core Competencies.” We believe that the skill, knowledge and know-how represented in these four competencies demonstrate advanced capacity in Disaster Risk Reduction and Management, based on our experience and on pilot testing with churches and church agencies.



CORE COMPETENCY 1:

Community Mobilization

Competency 1 is the ability to establish Disaster Committees that represent the diversity of the community. Committee members are trained in disaster preparedness, mitigation and response.

Community Mobilization is the ability to work with community and church leaders in all phases of programming. With a deep-rooted presence, the Anglican Church recognizes the value of community groups in managing their own development. The active engagement of community members in planning is a recognized strength of the local church.

All activities are designed, implemented, monitored and evaluated with community representation in mind. The experience, needs, roles, capacities, benefits and burdens of women and men, girls and boys, rich and poor, Anglicans and non-Anglicans, young and old are taken into account during the organizing process. This competency is fulfilled while recognizing that there are varying degrees of access to and control over resources, and that work, benefits and impacts may vary widely across different types of people. Community cooperation ensures that people have genuine input into decisions that will affect them. The Church's community organizers ensure wide-ranging consultations with all sectors of the population, thus reducing reliance on traditional elite power structures.

We believe that everyone has something to offer. Even the most vulnerable groups can contribute meaningfully by sharing ideas and knowledge, as well as providing skilled and/or unskilled labor and raw materials.

CORE COMPETENCY 2:

Risk Assessment

Competency 2 is the ability of leaders to complete and monitor a risk assessment plan. Risk Assessment takes into account the vulnerabilities, skills, knowledge and resources available within and outside the community. Like the first competency, a variety of community members are engaged: civic leaders as well as women, the elderly, people with disabilities, children and other marginalized groups.

1. HAZARDS OR THREATS

A risk assessment determines what hazards or threats are likely to occur in the community. It takes into account the vulnerabilities, skills, knowledge and resources available within and outside the community. Examples can include (but are not limited to):

- **Human-made: war, tribal fighting, unstable infrastructure or construction, looting**
- **Natural hazards: cyclones, floods, earthquakes, forest fires, landslides, drought**

2. VULNERABILITY

A risk assessment pays particular attention to the vulnerability of communities. Vulnerability is determined by looking at how people are able to protect themselves from disasters, and their resilience to its effects and impact. Factors contributing to vulnerability include (but are not limited to):

- **Lack of connectedness with others, lack of civil society movements**
- **Discriminatory practices (based on sex, age, race, class, sexual orientation, etc.)**
- **Poor access to financial, medical, education, human resources**
- **Poor access to government help, corruption in the government structures**
- **Environmental degradation**

3. CAPACITIES AND CAPABILITIES

The final element in risk assessment is determining community and individual capacities or capabilities. **Capacities mean the skills and assets that people or communities have which can be used for help in a time of disaster. Capabilities refer to longer-term strengths that are not focused on during a sudden change in circumstances.** Examples include:

- **Human: youth groups, Mothers Union**
- **Pastoral: parish ministries, spiritual resources, ecumenical networks**
- **Social: key parishioners, relationships with government officials**
- **Financial: property, access to equipment or transport, etc.**

A risk assessment analyzes the hazards, vulnerabilities and capacities in the community. A Disaster Risk Reduction strategy will diminish overall risk by reducing the hazards, reducing the vulnerabilities and increasing the capacities.

RISK

=

Hazards x Vulnerabilities

Capacities

STORIES FROM THE FIELD

Risk Mapping

by Leonidas Niyonabo (Anglican Church of Burundi)



This is my experience in mapping. I did a test. I went to an area where there was a drought. I went with the local priest, a local leader and representatives of the communities.

We met with the community outside near the church. We took sticks and we drew a map of the community in the dirt. An old lady drew the first map. Then we drew the boundary in the dirt. Other people took sticks and scratched in the dirt where the church would go, and marked the health center, market, schools, water sources, roads and houses. We asked where the hazards were and people drew the area where the well is dry or where it floods during the rains.

When we had all that drawn in the dirt, a young student, a girl in secondary school, then drew what we had in the dirt on a big piece of paper that everyone could see. Everyone, all the people told her, "No that doesn't go here it goes there." And then we all talked and agreed where everything went.

It was hazard mapping and resource mapping at the same time.

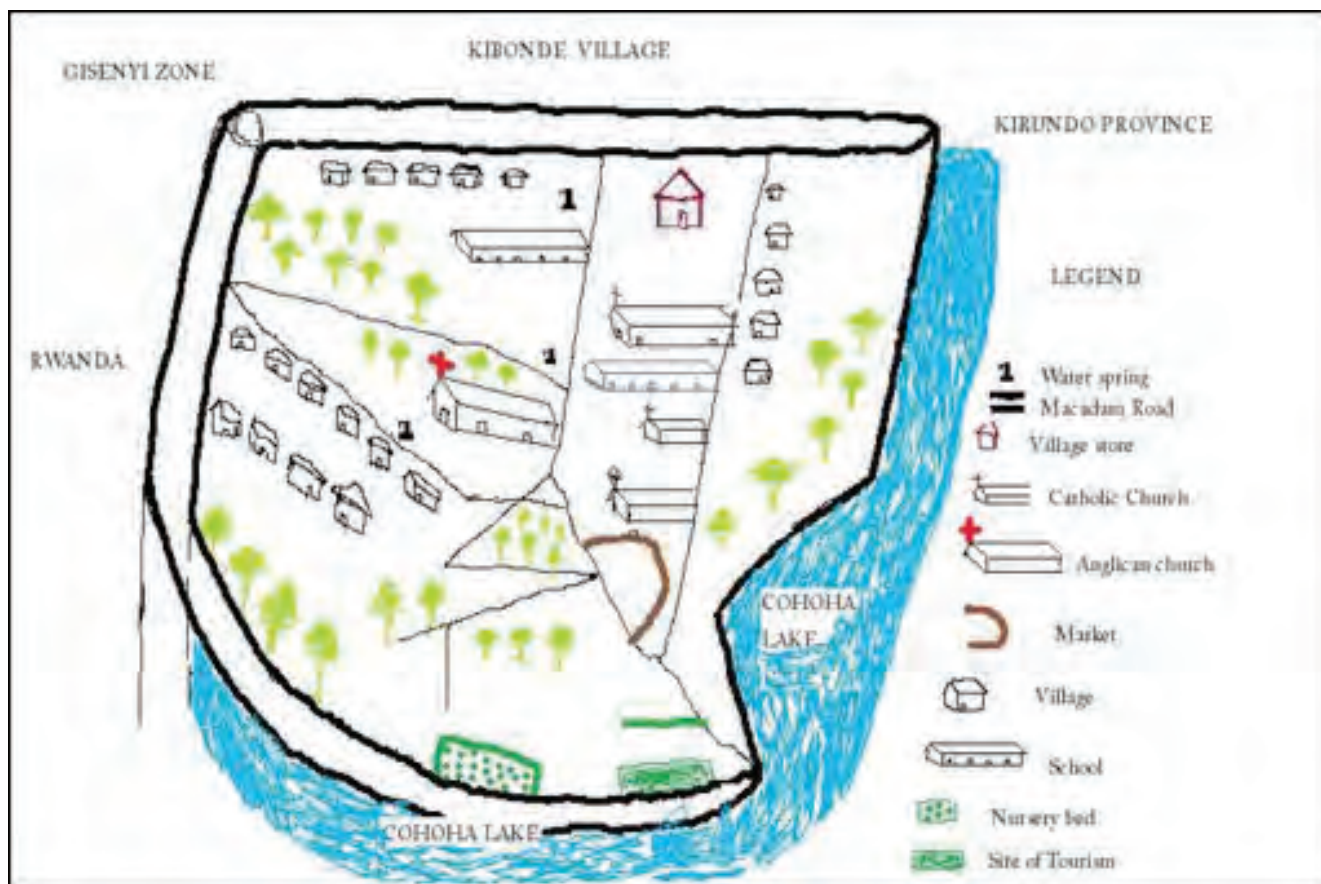

CORE COMPETENCY 3:

DRR Implementation

Competency 3 allows communities to develop and carry out a risk management plan to reduce the risks they face while incorporating the knowledge, skills and assets previously identified. Disaster Risk Reduction (DRR) Implementation refers to the ability to execute the plan, utilizing existing possessions, property and other assets to reduce risk.

DRR planning in a local community involves talking to a variety of people representing all parts of the community. The tools in this section are designed to allow people to put into action some of the solutions identified during the assessment phase.

DRR activities can be diverse and extensive. The purpose of this chapter is not to provide a complete list, but instead we hope to provide some simple tools that will enhance resilience at the household and community level.

DRR ACTIVITIES INCLUDE:

- **Establishing (and training on) early warning communication systems**
- **Making suggestions about household preparedness kits**
- **Strengthening community, parish or diocesan preparedness plans**
- **Incorporating risk resilience activities into development programming**

CORE COMPETENCY 4:

Disaster Response

Competency 4 is the ability of leaders to effectively respond to a disaster. They will be able to assess needs during a disaster response and will be able to respond in ways that line up with international standards.

Disaster Response refers to the ability to execute regular and normal relief and recovery activities that address both short-term and longer-term needs. We believe that incorporating Disaster Risk Reduction activities that will also build resilience against future shocks or disasters significantly strengthens such a response. Successful relief and recovery programs also take into account the strengths and contributions of the affected persons themselves, as well as local community and national organizations. An efficient and effective response must be both timely and inclusive.

We also recognize that suffering caused by disaster is rooted in poverty. It is the task of development programs to assist in reducing the level of this poverty and vulnerability to disasters. Disaster Response is best placed in the context of development. Response work can and should enhance development objectives instead of creating dependency. Responsible and effective relief efforts assist a return to normality as soon as possible. They achieve this goal by maintaining a long-term perspective on the development of the physical and human potential of an area and its communities.

The purpose of this section is to outline internationally recognized humanitarian principles, and to make them fit into the scope and nature of the church's response.

Select critical tools related to human resources are also provided to care for the humanitarian worker.

SECTION 4:

Capacity Assessment

Worksheet for monitoring Core Competencies

1

2

3

4

CORE COMPETENCY 1:

Community Mobilization

CORE COMPETENCY 2:

Risk Assessment

CORE COMPETENCY 3:

Disaster Risk Reduction Implementation

CORE COMPETENCY 4:

Disaster Response

Introduction

Churches and church-related organizations within the Anglican Communion may have different levels of capacity and experience with Disaster Risk Reduction. Our Toolbook aims to be useful no matter where you fall in the scale of capacity and experience. In other words, you may just be starting out and all these ideas are new to you. There are tools for you. Or you may have many years of responding to disasters. We have tools for you, too. We also believe that Anglican churches and related agencies, no matter what their current level of capacity, will be able to build and enhance their capacity to an advanced professional level using this Toolkit.

In our review of existing literature, our Working Group examined many available resources. However, we could not find the necessary tool to meet two of the needs identified above: enhancing **Disaster Risk Reduction** capacity, and enhancing **Disaster Management** capacity. Thus, the Working Group developed an assessment worksheet to meet these needs.

The Working Group agreed on eight core minimum standards to meet all four Core Competencies listed, as detailed in the following graphic. These competencies and standards are really goals to try to attain. By striving to meet these goals, Anglican churches, agencies and others will be responding to hazards in the most professional and effective manner possible.

In order to guide you through the various activities, we have created a **Capacity Assessment Worksheet** that includes the monitoring of both Disaster Risk Reduction and Disaster Management capacities. This worksheet is for you to use before, during and immediately after a disaster. You would use it before a disaster so that it will be easier to respond more effectively when something does happen. And you would use it during and immediately after a disaster happens to ensure that you are maintaining professional standards.

The **Capacity Assessment Worksheet** is a monitoring tool to maintain simplicity and connectedness across and between the four competencies. The scores provide benchmarks of capacity and reflect any change in capacity.

Capacity Assessment Overview

CORE 1	CORE 2	CORE 3	CORE 4
<p>Community Mobilization</p> <p>1</p> <p>STANDARDS</p> <p>DRR & Management Workshops</p> <p>DRR & Management Leadership</p>	<p>Risk Assessment</p> <p>2</p> <p>STANDARDS</p> <p>Risk Assessment</p>	<p>Disaster Risk Reduction Implementation</p> <p>3</p> <p>STANDARDS</p> <p>Risk Management Plan</p> <p>Integrating DRR</p>	<p>Disaster Response</p> <p>4</p> <p>STANDARDS</p> <p>Needs Assessment</p> <p>Relief Activities</p> <p>Staff Care</p>
<p>TOOLS</p> <ol style="list-style-type: none"> 1 Serving the Wider Community 2 Workshop for Community or Parish Leaders 3 Workshop for Church Leadership 4 Committee Roles & Responsibilities 5 Developing a Committee Work Plan 6 Disaster Coordinator Job Description 	<p>TOOLS</p> <ol style="list-style-type: none"> 7 Basic Mapping Exercises 8 Comprehensive Mapping Exercises 	<p>TOOLS</p> <ol style="list-style-type: none"> 9 Prioritizing Activities 10 Early Warning System 11 Communication System 12 Evacuation Centers 13 Community Drills 14 Household Preparedness Kits 15 Managing Volunteers 16 Risk Reduction Programming 17 DRR Indicators 	<p>TOOLS</p> <ol style="list-style-type: none"> 18 Relief Assessment Format 19 Recovery Assessment Format 20 Core Principles 21 Thematic Tip Sheets 22 Risk Reduction in Disaster Relief & Recovery 23 Staff Care Policy 24 Recognizing and Managing Stress

NAME OF COMMUNITY/PARISH: _____

DATE OF ASSESSMENT: _____

COMPLETED BY: _____

SCORING:
 Novice A = **0**
 Beginner B = **+1**
 Intermediate C = **+2**
 Advanced D = **+3**

Capacity Assessment Worksheet

The Worksheet is an assessment monitoring tool to maintain simplicity and connectedness across and between the four competencies. The scores provide benchmarks of capacity and reflect any change in capacity. Tally your scores at the end of the Assessment Worksheet to determine your Core Strength and find recommended Capacity-Building Tools.

CORE COMPETENCY 1: Community Mobilization

**1 STANDARD 1:
 Disaster Risk Reduction & Management Workshops**

Have you conducted any workshops?

- A. No. **A.** _____
- B. Yes and we discussed what worked, what might have gone better and next steps for improvement. Some of our leaders understand Disaster Risk Reduction (DRR) concepts, such as hazards and vulnerabilities. **B.** _____
- C. Yes, more than one workshop with a parish committee or community board. Most church and workshop leaders understand DRR concepts. **C.** _____
- D. Yes, including workshops with the wider community, Anglican churches and church leadership. Many community and parish members understand DRR concepts. **D.** _____

CAPACITY-BUILDING TOOL 1: Serving the Wider Community - p. 5.1 **TOOL 2:** Community or Parish Leaders - p. 5.3;
TOOL 3: Church Leadership - p. 5.5;

CORE COMPETENCY 1: Community Mobilization

**2 STANDARD 2:
 Disaster Risk Reduction & Management Leadership**

Have you formed a committee?

- A. No. **A.** _____
- B. Yes, we formed a diverse* committee. The committee doesn't meet very often, or has not decided its mission or chosen a coordinator. **B.** _____
- C. Yes, we formed a diverse DRR Committee. All the members have been trained. The committee identified responsibilities for the coordinator and each member. If there is a coordinator, he or she is mainly responsible for coordinating during emergencies. **C.** _____
- D. Yes, DRR Committee members are diverse, have been trained and know their roles and responsibilities. The committee meets monthly to review and enhance the DRR plan. A full-time committee coordinator helps the committee do its work. **D.** _____

CAPACITY-BUILDING TOOL 4: Committee Roles & Responsibilities - p. 5.7; **TOOL 5:** Committee Work Plan - p. 5.9;
TOOL 6: Disaster Coordinator Job Description - p. 5.11

*Diverse = represents the community through inclusion of different ethnic groups, tribes, religions, etc.

CORE COMPETENCY 2: Risk Assessment

3 STANDARD 3:
Risk Assessment

Have you conducted a risk assessment?

- A. No. A. _____
- B. Yes, the DRR Committee conducted a basic workshop to identify hazards, vulnerabilities and capacities. B. _____
- C. Yes, the DRR committee conducted a basic workshop to identify hazards, capacities and vulnerabilities. Community members were invited and attended the workshop. C. _____
- D. Yes, an extensive workshop was held to identify hazards, capacities and vulnerabilities. Attendees were diverse. D. _____

CAPACITY-BUILDING TOOL 7: Basic Mapping - p. 5.13; **TOOL 8:** Comprehensive Mapping - p. 5.17

CORE COMPETENCY 3: Disaster Risk Reduction Implementation

4 STANDARD 4:
Risk Management Plan

Have you conducted a community risk analysis?

- A. No. A. _____
- B. The DRR Committee conducted a community risk assessment. B. _____
- C. The DRR Committee led a risk analysis in each community and the participant group is diverse. C. _____
- D. DRR Committee led a risk analysis in each community, the participant group is diverse and the committee checked with each segment of the community more than once to see if they are using the plan and to help update the plan. D. _____

CAPACITY-BUILDING TOOL 9: Prioritizing Activities - p. 5.21; **TOOL 10:** Early Warning System - p. 5.25; **TOOL 11:** Communication System - p. 5.27; **TOOL 12:** Evacuation Centers - p. 5.29; **TOOL 13:** Community Drills - p. 5.31; **TOOL 14:** Household Preparedness Kits - p. 5.33; **TOOL 15:** Managing Volunteers - p. 5.35

CORE COMPETENCY 3: Disaster Risk Reduction Implementation

5 STANDARD 5:
Disaster Risk Reduction Integration

Do community development projects integrate DRR activities?

- A. No. A. _____
- B. Yes, when planning for development projects the community considers vulnerabilities that might be limited or weakened during a disaster. B. _____
- C. Yes, planning for all development projects includes risk analysis and budgeting for DRR projects. C. _____
- D. Yes, not only does planning for all community projects include risk analysis and budgeting for DRR projects, but DRR integration also includes tracking indicators to assess the impact of DRR projects. D. _____

CAPACITY-BUILDING TOOL 16: Risk Reduction Programming - p. 5.37; **TOOL 17:** Disaster Risk Reduction Indicators - p. 5.39

CORE COMPETENCY 4: Disaster Response

6 STANDARD 6:
Disaster Response Needs Assessment

Have you conducted a needs assessment?

- A. No. **A.** _____
- B. Yes, communities carried out one or more needs assessments for affected community members. Assessment included providing priority for vulnerable** populations. **B.** _____
- C. Yes, needs were assessed using this workbook. And the assessment data was reviewed in the context of the community's existing strengths and capacities. **C.** _____
- D. Yes, not only were needs assessed using this workbook, but also the community worked with other organizations to develop a response plan that addresses vulnerabilities and vulnerable populations. **D.** _____

CAPACITY-BUILDING TOOL 18: Relief Assessment Format - p. 5.41; **TOOL 19:** Recovery Assessment Format - p. 5.43

CORE COMPETENCY 4: Disaster Response

7 STANDARD 7:
Disaster Response Relief Activities

Have you developed a response plan?

- A. No. **A.** _____
- B. Yes, we developed a plan that addresses basic and urgent survival needs in the immediate aftermath of a disaster. **B.** _____
- C. Yes, not only was a plan developed based on immediate community needs after a disaster, but the plan follows "minimum standards" for essential needs, such as water, sanitation, shelter and food. **C.** _____
- D. Yes, in addition to addressing immediate community needs post-disaster and following "minimum standards" for essential needs, the plan covers early recovery, reducing risk and enhancing the community's ability to prevent and minimize future hazards. **D.** _____

CAPACITY-BUILDING TOOL 20: Core Principles - p. 5.47; **TOOL 21:** Thematic Tip Sheets - p. 5.49;
TOOL 22: Risk Reduction in Disaster Relief & Recovery - p. 5.53

CORE COMPETENCY 4: Disaster Response

8 STANDARD 8:
Disaster Response Staff Care

Have you developed practices and guidelines to ensure staff care?

- A. No. **A.** _____
- B. Yes, staff and volunteers are provided counseling support as needed. **B.** _____
- C. Yes, and also guidelines are in place for pastoral and professional counseling. **C.** _____
- D. Yes, in addition to guidelines that allow for counseling support, staff were trained to identify psychosocial symptoms. **D.** _____

CAPACITY-BUILDING TOOL 23: Staff Care Policy - p. 5.55; **TOOL 24:** Recognizing and Managing Stress - p. 5.57

**Vulnerable = Women, children, elderly and the infirm.

SECTION 5:

Tools

The Tools found in Section 5 are designed for Development Staff, Church Leadership and Parish/Community members to provide ideas, instructions, guides and information for Disaster Risk Reduction and Disaster Management.



Staff



Church Leadership



Parish/Community

CORE 1

Community
Mobilization

STANDARD 1

DRR
Workshops



TOOL 1:

Serving the Wider Community

What is it?

Guidelines for working with and providing assistance to groups or communities other than the Anglican community.

Why use it?

These guidelines are designed to assist you in working with communities or leaders who are not specifically Anglican.

How to use it?

Many times, we are called on to provide assistance to communities that are outside our own Anglican community. There is a place for us to help our neighbors even when we do not share the same language or religious beliefs. The International Red Cross and Red Crescent Movement created a code of conduct for NGOs to follow that many churches have adopted. Two of the key principles are:

And the King will answer them,
*“Truly I tell you, just as
you did it to one of the
least of these who are
members of my family,
you did it to me.”*

Matthew 25:40

1. Church assistance and support should be given to people of any race, belief, gender, religion and nationality, without bias or prejudice. Priorities are to be worked out on the basis of need alone. This means that we need to help everyone regardless of what group they are in.
2. Church assistance and distribution should not be used to promote a particular political or religious standpoint. This means that we cannot proselytize.

Once we recognize and agree with these principles, in sticky situations how can we follow them? How can we work with leaders from other faiths to help a community that is not Anglican?

Be Kind.

**Work
Together.**

**Honor
Traditions.**

Ask, ask.

KEY THINGS TO CONSIDER:

1. **Meet with religious leaders, ethnic leaders and community leaders.** Ask for a meeting to discuss the needs of the community. Importantly, be very open about your intentions and hopes. Your intentions are to help the people and not to convert them or do harm. Answer all questions with calmness and compassion. Think about how you might feel if someone from another faith came to your neighborhood to give you assistance.
2. **Partner with the local leaders.** Plan with them what the response to disaster will be and how it will be carried out. Do not take any action without their involvement and partnership. This means if you do a food distribution, include representatives from the partner group to carry it out. Work together. When you decide which families will get help, decide with someone from the other group. Never take action alone.
3. **Know the local customs, traditions and values.** Lay aside your own customs and traditions to honor those of the community where you want to serve. This may mean attending religious services to demonstrate your goodwill and honor their practices. Keep thinking about how you would feel if you were in their shoes.
4. **Never assume you know what is right,** how things should be done or what is the best way to proceed.

Tool History: Developed and field-tested in Sri Lanka

NEXT STEP: Tools 2 & 3: Conducting DRR Workshops **Tool 4:** Committee Roles & Responsibilities

TOOLS **5.1**

CORE 1

Community
Mobilization

STANDARD 1

DRR
Workshops



TOOL 2:

Workshop for Community or Parish Leaders

What is it?

A participatory workshop on Risk Reduction to target parish and community leadership.

Why use it?

This workshop prepares participants for subsequent risk reduction activities. Although many of the risk reduction activities will be facilitated by program staff or committee members, it is useful to share general ideas with community and church leaders.

How to use it?

1. Depending on the situation, it is sometimes important to get community leaders on board before meeting with the wider community. At other times, a ground-up approach is more effective.
2. Ask the bishop or community leader for their blessing and identify an appropriate time and place.
3. Confirm and reserve a location with adequate space for breaking out into small group discussions.
4. Use or adapt the suggested paragraph below to send out invitations to at most 25 people. Invite parish wardens and leaders, civil society members, village elders and youth leaders. Pay close attention to demographic representation, including adequate female, elder and youth participation.

Suggested Invitation Text:

You are cordially invited to attend a workshop on understanding, thinking about and reducing the disaster risk in your community/parish/diocese. In order to build a set of activities to strengthen your community's/parish's/diocese's ability to recover after a disaster, we seek your participation. This workshop will last three hours and will be held at:

5. If you do not yet have a strong relationship with your audience, or if you are building this relationship, you may consider co-facilitating with a parish or community leader.
6. Prepare logistics, including arranging:
 - Transportation for participants
 - One flipchart with stand or other presentation device for every eight people
 - Seating in a circle for participants

Tool History: Adapted and field-tested in Burundi, El Salvador

Reference: Hansford, B (2006). *Disasters and the Local Church*, Tearfund.

TOOL 2: At the Workshop

1. Ask these questions to the entire group, and encourage full participation:
 - Have you or your family ever had a major family crisis? Discuss your emotions, fears and the actions that your family members took.
 - Can anyone remember any kind of disaster that has happened in our area? What was its impact?
 - How did the community respond?
 - Can anyone remember any situation that would have become a disaster if the right action had not been taken in time? What actions were taken that prevented more serious consequences?
 - How would your community respond if a disaster, such as a major road accident or a fire, involving many casualties, struck tomorrow?
 - What kind of disaster do you fear most? Why? Is there anything that could be done to lessen the impact of this kind of disaster?
2. Divide the group into groups of eight to discuss types of hazards – natural and human-made. After 10 minutes of group work, ask each group to present their work to the full plenary.
 - What kind of hazard would be most likely to threaten our community? Are there any warning signs? Draw up a list.
 - What circumstances make certain hazards common in our community? You might include building with grass or palm leaves, dry grass in the bush that may lead to bush fires, too much rain, insects destroying a crop or people living on steep hillsides, etc.
 - How well equipped are the local authorities to cope with any of these events?
 - How well equipped is our community to deal with any of these events?
3. Divide the group into different groups of eight to discuss the varying impact of disasters on certain groups of people. After reading the short scenario below, ask the small groups to discuss the questions below for 10 minutes. Allow time for the groups to present their work to the full plenary.

“Imagine that a large dam across a big river, some 100km upstream of our community, develops huge cracks. The authorities know that it is likely to burst within the next 24 hours. They warn all communities downstream to evacuate immediately using radio broadcasts and officials with loudspeakers.”

 - Discuss how people in your community would be affected.
 - What would be the quickest and safest escape route to use?
 - Consider the different types of people in our community. How will they be affected immediately following a disaster, and in the long term after several weeks or months?
 - Who is most likely to suffer serious effects? Why?
 - How could you plan to help the groups of people likely to suffer the most serious impact?
 - What local organizations might be able to help you?

4. Divide people into pairs and read this story aloud:

“You wake up and realize your house is on fire. The entire roof is on fire and there is nothing you can do to save the house. There is no one else in the house. You have just two or three minutes to take out with you the five things that are most important to you. What would you take out?”

 - Give people a few minutes to decide which five things they would take out first.
 - Then ask each pair to decide which item they would take out first and why.
 - Ask several pairs to share with the full group what items they have chosen. Explain that they have made a priority list. From all their possessions, they prioritized the five most important. Then they decided on their top priority and gave the reasons for this.
 - After people have shared their first priority, discuss whether this would benefit the whole community. Should people reconsider their priorities?
5. Try a similar exercise, this time considering community priorities:

“You hear on the radio that a cyclone is bringing severe winds and that flooding will reach your area in one hour’s time. Think about your community and decide which five actions you would take to avoid or minimize the damage to life, livestock or possessions.”

With the full group, discuss community assets and resources using the questions below:

 - List all the community leaders in your area, both government and non-government. In an emergency situation, who provides directions? When confusing and sometimes different directions are given by those in authority, whose directions are followed?
 - What experience do these leaders have in organizing people? What experience do they have in planning? How could their experience be widened to help prepare for disaster response?
 - How closely linked are these leaders to government officials? How can links between government officials, church groups, NGOs and community groups be strengthened and communications improved?
 - How effective are church groups in training and preparing members for leadership? How can this be improved?
6. As a final step, review with the participants how the Disaster Risk Reduction Committee will use the information gathered from this workshop and the tools in this book to enhance a plan of activities to reduce their community’s risk over the course of the next few months.
7. Record the information collected, and keep it in a safe place for future use.

CORE 1

Community
Mobilization

STANDARD 1

DRR
Workshops



TOOL 3:

Workshop for Church Leadership

What is it?

A participatory workshop on Risk Reduction to target church and diocesan/provincial leadership.

Why use it?

This workshop prepares participants for subsequent risk reduction activities. Although many of the risk reduction activities will be facilitated by program staff or committee members, it is useful to share general ideas with church and diocesan/provincial leadership.

How to use it?

1. Ask the bishop or archbishop for their permission or blessing and identify an appropriate time and place.
2. Confirm and reserve a workshop location with adequate space for breaking out into small group discussions.
3. Use or adapt the suggested paragraph below to send out invitations to at most 25 people. Invite diocesan leaders, including laypersons, archdeacons, deans and department heads. Pay close attention to demographics to have a balanced representation, including adequate female, elder and youth participation.

Suggested Invitation Text:

You are cordially invited to attend a workshop on understanding, analyzing and reducing the disaster risk in your community/parish/diocese. We request your participation in order to build a set of activities to strengthen your community's/parish's/diocese's resiliency following a disaster. The workshop will last three hours and will be held at:

4. Prepare logistics, including arranging for:
 - Transportation for participants
 - One flipchart with stand or other presentation device for every eight people
 - Seating in a circle for participants

Tool History: Adapted and field-tested in Brazil, Burundi, El Salvador

Reference: Venton P and Hansford, B (2006). *ROOTS 9: Reducing Risk of Disaster in Our Community*, Tearfund.

TOOL 3: At the Workshop

1. Ask these questions to the entire group, and encourage full participation:
 - In what ways do you think your church could respond immediately if a disaster occurred?
 - What plans could your church develop now, so it could respond quickly if and when a disaster occurred?
2. Divide the group into groups of eight to discuss church assets. After 10 minutes of group work, ask each group to present their work to the full plenary.
 - What assets or resources does your church have that could be useful in a disaster? Think about land, buildings, bells, etc.
 - What useful information could your church communicate both before and during a possible disaster?
 - What skills do you have in your congregation? Some examples include medical knowledge, construction experience and counseling ability.
3. Divide the group into different groups of eight to discuss how church leaders can model and encourage compassionate attitudes and values. Ask the small groups to discuss the questions below. After 20 minutes of group work, have the groups present their work to the full plenary.
 - How can the church show love and hospitality in times of crisis?
 - In what ways could your church support those who were bereaved or emotionally upset by a disaster?
 - What values and attitudes in your community make some people more vulnerable to disaster? Does community culture support fatalism or superstition?
4. Divide people into pairs to enter into deeper dialogue on facilitating community action.
 - How can your church challenge and change these values and attitudes?
 - What are the key teachings that the church should promote after a disaster?
 - What sources of conflict exist in your community and what can the church do to help resolve those tensions?
 - How can the church ensure that everyone in the community who needs help gets it?
4. Divide people into pairs to enter into deeper dialogue on facilitating community action.
 - How could your church bring together the wider community to decide on action to prepare for or respond to disasters?
 - Who are the key people in your community that you would want to involve in planning and running such a community meeting?
5. With the full group, discuss how the church can use its networks to be an advocate on behalf of those most vulnerable.
 - Are there issues of injustice in your local community that need to be challenged? How can your church best do this?
 - Who are the people in your community who might be overlooked by emergency response programs due to geographic factors or lack of connections?
6. Lastly, share with participants how the Disaster Risk Reduction Committee will use the information gathered from this workshop and the tools in this book to enhance a plan of activities to reduce their community's risk over the course of the next few months.

The Diocese of Colombo Clergy and Laity Disaster Risk Reduction Workshop



CORE 1

Community
Mobilization

STANDARD 1

DRR
Leadership



TOOL 4:

Committee Roles & Responsibilities

What is it?

A list of the core roles and responsibilities of a Disaster Risk Reduction and Management Committee.

Why use it?

You need a committee or group to be able to respond well in an emergency. And you need the experience of the members to match the needs and expectations of the committee.

How to use it?

1. The primate, bishop or community leader should invite the following to serve on committee:
 - Clergy including primate, bishop, parish priest, etc., as appropriate
 - Lay leaders including select parish wardens and community chiefs
 - Department representatives including Mothers' Union, Youth Associations, etc.
 - People with expertise and/or connections with disaster management
 - People with experience in planning and monitoring
 - People willing and able to help in designated areas of responsibility
 - People from other faiths and backgrounds

Suggested Invitation Text:

The Diocese/Parish/Community Development Organization of _____ is planning to set up a Disaster Risk Reduction and Disaster Management Committee. The Committee will work on a Disaster Risk Reduction Plan for our diocese/parish/community. The Committee will also supervise the Disaster Risk Reduction and Disaster Management Coordinator. We are seeking a group of committed individuals willing to support the Coordinator and the diocese/parish/community in preparedness, mitigation and response efforts. We are inviting you to serve on this Committee for a minimum of two years.

2. **The committee will be responsible for the following activities:**
 - Mirroring Christ's and other great spiritual leaders' commitment to truth, mercy, justice and love for all people
 - Establishing Disaster Risk Reduction goals and objectives
 - Developing, reviewing and fully understanding the Disaster Risk Reduction plan
 - Leading drills or trainings as needed
 - Communicating the plan fully to parishes and communities through trainings, sermons, etc.
 - Ensuring that preparedness activities continue and are current
 - Providing parish support during stressful times; for example, coordinating services and activities
 - Providing leadership support and guidance to the coordinator as needed
3. **During monthly meetings, the committee will move forward on the following actions:**
 - Knowing their own area of responsibility within the plan
 - Reviewing and updating the plan regularly to make sure it is operational
 - When a disaster strikes, implementing the preparedness plan or the post-disaster plan
 - Evaluating the plan after use; making changes as needed
 - At regular intervals, inviting new members to join the committee

Tool History: Developed and field-tested in El Salvador, Mozambique, Solomon Islands

Reference: US Disaster Program (2011). *Preparedness Planning Guide*, Episcopal Relief & Development.

STORIES FROM THE FIELD

Forming Committees in El Salvador

by Daniella Flamenco



At first, when the bishop talked about Disaster Risk Reduction the priests were excited because they thought they would get funding. We had to deal with their disappointment when they realized that they weren't going to get any funds.

Later I tried to meet with the priests without the bishop, but no one would show up. I had to make sure the bishop was there so everyone would participate.

One of the first things we worked on was getting a DRR Coordinator. What we found is that the coordinator doesn't have to be the priest's closest friend. That person might be too busy. Also, you don't want to choose someone who is too close to the priest – you need a little bit of objectivity and distance.

The ideal coordinator is someone who has time, who is committed and is somewhat educated. The coordinator doesn't need to have attained the highest education level, just enough to read and understand some of the ideas about DRR. Too much education can also be a problem because sometimes the most professional people in a community are too busy with their other work.

If a group chooses people to be coordinators and committee members who aren't quite the right fit, you should intervene early. One priest first chose a nurse, but we discovered that she would be too busy to be active. He then chose a doctor who had a clinic at the parish – the doctor has much more time, and he is prepared and has the knowledge.

In our case, the committees in each community are made up of health promoters, priests and a few people the priest selects. Committees are between four to five members. I think five is a good number.

CORE 1

Community
Mobilization

STANDARD 1

DRR
Leadership



TOOL 5:

Developing a Committee Work Plan

What is it?

An exercise to provide guidance on developing and updating a Disaster Risk Reduction work plan.

Why use it?

Without an action plan, the task of reducing risk or managing disasters may seem daunting. This simple exercise is designed to simplify the process and make it more manageable.

How to use it?

1. Make a chart like this one, labeling the first column "Activities." List all essential activities and continue with additional activities. Make the first row, "Timeline." Along the first row, write down a realistic time frame using weekly, monthly or quarterly time units. On the grid, enter a check or a more specific date when the committee expects the activities to take place.

ACTIVITIES
Facilitate DRR Workshops Tools 1 & 2
Recruit DRR Coordinator Tool 4
Establish DRR Committee Tool 5
Conduct Risk Mapping Tools 7 & 8
Compile a Contact List Tool 11

	MONTHLY TIMELINE			
	Jan-Mar	Apr-June	July-Sept	Oct-Dec
		May 1		
			August 20	October 20
		June 15		

2. In this example, the community planned to appoint a DRR Coordinator by May, and have the committee work plan and contact list completed by June. They thought that they would hold the meetings with the communities in August and October. As they planned other activities they would add these to this list. Design this work plan for the diocese as a whole or for a specific community or parish.
3. The coordinator and the committee should draft and approve this work plan at their first meetings, and then continue to monitor the activities, and revise if necessary, in subsequent meetings.
4. Keep this printed list available to reference and update the plan.

Tool History: Developed and field-tested in Burundi, El Salvador, Myanmar, Sri Lanka

CORE 1

Community
Mobilization

STANDARD 1

DRR
Leadership



TOOL 6:

Disaster Coordinator Job Description

What is it?

A sample job description for a Disaster Risk Reduction and Management Coordinator, if your diocesan or provincial leadership decides that you need a part-time or full-time person to coordinate and manage disaster risk reduction activities.

Why use it?

Recruitment of an appropriate volunteer or staff person with a clearly defined mandate is essential for overseeing and organizing disaster mitigation and preparedness programming, and when needed, for coordinating relief and recovery operations.

How to use it?

1. Use the language below to discuss with your provincial or diocesan leaders and create a job description that meets your local needs.
2. Determine if the position is voluntary or paid, and full-time or part-time, and mention this in the job description. *NOTE: We do not recommend that clergy do this job because when a disaster strikes, clergy will be required to meet the spiritual and emotional needs of the affected population and they will not have time or energy to lead a disaster response.*
3. Post the job description within the church, ecumenical and civil society networks.
4. When interviewing candidates, ensure the applicants fully understands their roles and responsibilities, including empowering parishes and communities through activities before, during and after a disaster.

SAMPLE JOB DESCRIPTION

Duties and responsibilities include:

- Recruiting a Disaster Risk Reduction and Disaster Management Committee
- Supporting DRR Committees at provincial, diocesan and parish/community levels
- Facilitating regular meetings of the DRR & DM Committee
- Coordinating and planning trainings at diocesan, parish and community levels
- Facilitating the creation and maintenance of a Disaster Preparedness Plan
- Assisting parishes/communities in establishing local committees and creating/ updating disaster plans
- Building relationships with other ecumenical, non-profit and governmental agencies
- In the event of a disaster, communicating with local committees to assess needs and assist in implementing response plans
- In the event of a disaster, coordinating with partners regarding needs and how best to get needed resources to affected communities
- Any other duties as assigned by supervisor, the committee or the bishop

Qualifications include:

- Positive energy and the ability to work collaboratively with clergy and lay people from diverse backgrounds and different levels of comprehension
- A self-motivated, detail-oriented person with strong organizational skills
- Superior oral and written communication skills, experienced public speaker

Tool History: Developed and field-tested in El Salvador, Mozambique, Solomon Islands

CORE 2

Risk
Assessment

STANDARD 3

Risk
Assessment



TOOL 7:

Basic Mapping Exercises

What is it?

Basic exercises to identify the hazards, vulnerabilities and capacities in a community, which by the end of the process will give you a completed Risk Map.

Why use it?

A Risk Map is useful in assessing the intensity, frequency and trends of hazards; analyzing the levels of vulnerability of people and facilities; and identifying opportunities to build on existing strengths.

How to use it?

1. Mapping

This exercise is helpful in facilitating communication and encouraging discussion on important issues in the community. A map allows everyone to see the area's main features and where there might be problems in the case of a disaster.

1. **Make sure that men and women who know the area well and are willing to share their experiences come to the meeting.** If you have all new people or small children you won't get the information that you need.
2. **Choose a suitable surface to work on** (ground, floor, paper) and medium (sticks, stones, seeds, pencils, chalk) for the map.
3. **Help people get started, but let them draw the map themselves.** The map should first identify the spatial arrangement of houses, fields, roads, rivers and other land uses. It should then indicate, for each hazard, elements at risk, safe areas, resources etc.

EXERCISE 1

Mapping

Areas at Risk



Safe Areas



TOOL 7: At the Workshop

EXERCISE 2

Seasonal Calendar

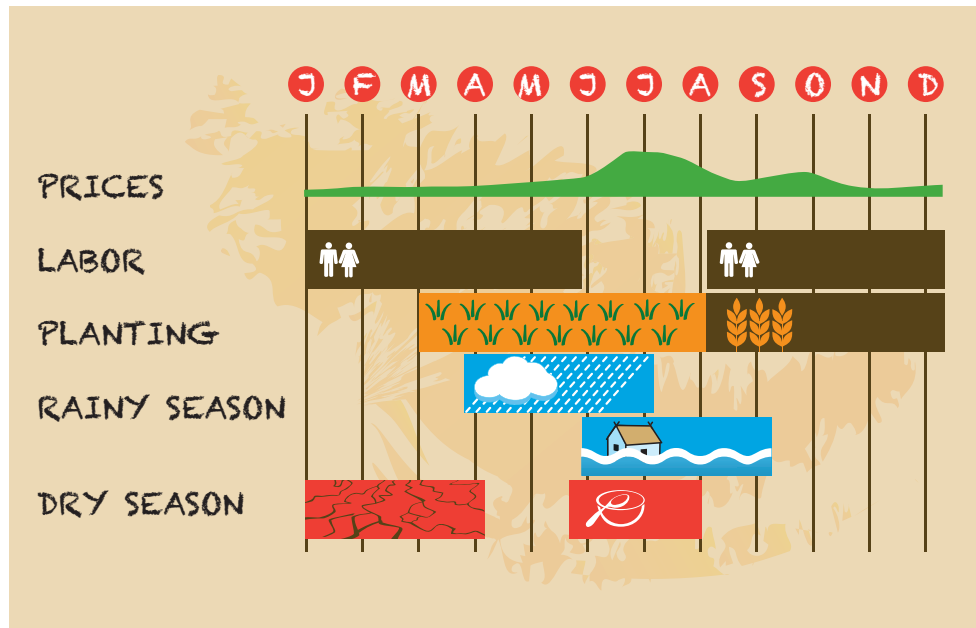

2. Seasonal Calendar

This exercise reveals different events, experiences, activities and conditions that occur throughout the year and identifies periods of stress and hazards, illustrating when activities and events are most at risk as well as the “safe” seasons.

1. Use ‘blackboard’ or craft paper. Mark off the local calendar months of the year on the horizontal axis. Ask people to list sources of livelihood, events, conditions, etc. and arrange these along the vertical axis.
2. Ask people to enumerate all the work they do (i.e., plowing, planting, weeding, etc.) and mark months, duration, gender and age for each source of livelihood/income.
3. Talk about how the different disasters affect the community. Look at the calendar and say things like, “You usually plant in June but then there are heavy rains that month – how does that impact your ability to plow and make a good living?” In this way, you are linking the different aspects of the calendar: how do disasters affect sources of livelihood? When is workload heaviest? Who does the work? Ask about seasonal food intake, periods of food shortage, out-migration, etc.

TOOL 7: At the Workshop

EXERCISE 3

Capacity Map

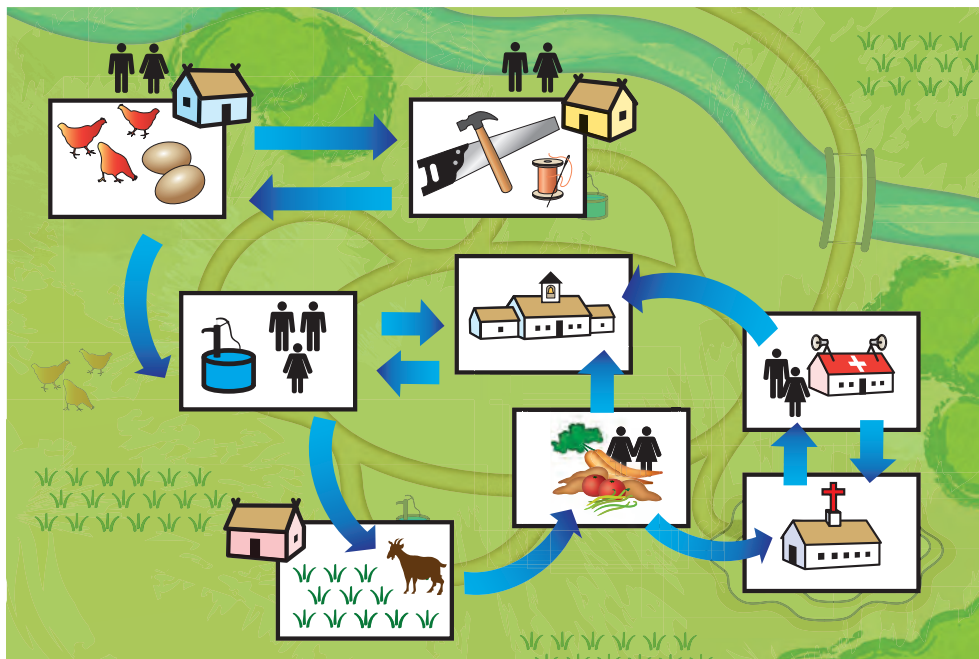

3. Capacity Map

This exercise is helpful in exposing local resources on which people rely in times of disaster. This allows communities to act on existing capacities or strengths. It will also help to identify gender differences in access to and control over resources.

1. Ask a household to draw a map of their household and resources/capacities on which they depend for their livelihood or survival (material/physical, social/organizational, spiritual/motivational capacities).
2. Ask a household how they contribute to or support other households, the community and the larger socioeconomic environment.
3. Ask people to use arrows to indicate flow of resources to and from their household.
4. Ask household member(s) who uses and controls resources (by gender, class, ethnicity, age).
5. Ask questions to accompany the making of the maps, and put answers on the map.

Tool History: Developed and field-tested in China, El Salvador, Myanmar, Philippines, Sri Lanka

NEXT STEPS: **Tool 8:** Comprehensive Mapping Exercise
(if operating at higher capacity levels, or needing additional information)

Tool 9: Prioritizing Activities (for stand-alone DRR activities)

Tool 16: Risk Reduction Programming (for integrating into development programs)

CORE 2

Risk
Assessment

STANDARD 3

Risk
Assessment



TOOL 8:

Comprehensive Mapping Exercises

What is it?

A series of additional mapping exercises to identify hazards, vulnerabilities and capacities, and provide more comprehensive information (supplements Tool 7 exercises).

Why use it?

Mapping exercises build community participation and ownership for the process. Therefore, these additional exercises will not only collect different types data for community analysis, but they will also continue to create opportunities for the community to address hazards and vulnerabilities within the framework of their own existing assets and strengths.

EXERCISE 1

Historical
Profile

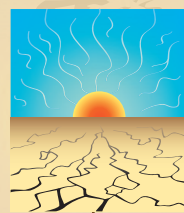

DROUGHT



LANDSLIDE



FLOODING



POLITICAL

How to use it?

1. Historical Profile

This exercise is used to get insight into past hazards and changes in the hazard's characteristics, and to understand the present situation in the community.

1. **Schedule a time for community members to come together and discuss things that have happened in the community.** Make sure to invite as many people as possible, including those with historical knowledge of the community and local governance (elder leaders, teachers) and young people so they can hear the history of their community.
2. **When the meeting starts,** explain that you are gathering stories about the history of the community in order to come up with a map of current risks.
3. **Ask people to recall any prior major events in the community, such as:**
 - Major hazards and their effects (floods, earthquakes, droughts, cyclones)
 - Changes in land use (crops, forest cover, etc.)
 - Changes in land tenure or who owns the land
 - Changes in food security and nutrition

TOOL 8: At the Workshop

- Changes in social services (health status, education facilities)
 - Changes in administration and organization
 - Changes in the roles of men, women, boys, girls, elderly, disabled
 - Major political events
4. Ask someone to write the stories down on a blackboard or craft paper in chronological order. If, for example, a flood happened in 2010 and a crop failure in 1999 and then another flood last year, you would write the 1999 event first, then the 2012 event and finally the one that just happened.
 5. Ask people to tell stories about their lives that have to do with hazards, such as the time there was a flood or when the crops all failed.
 6. Ask individuals or a group to begin with current experiences and to go back in time. The purpose of this history tracing is to find reasons/causes that contributed to the occurrence of a certain experience. Make sure you keep a record of this information.

EXERCISE 2

Transect Walk

Note historic changes along the transect. Focus on issues like land use, problem areas, land tenure, and changes in the environment.

The diagram illustrates a transect walk across a landscape. From left to right, the features are: a river labeled 'FISHING', a field labeled 'GRAZING', two houses labeled 'HOMES', a water source labeled 'WATER', a field with a cow labeled 'LIVESTOCK', and a field with trees labeled 'FIREWOOD'. Below the diagram is a table for recording observations.

	GRAZING	FARMING	HOMES	WATER	LIVESTOCK	FIREWOOD
LAND USE						
SOIL/DRAINAGE						
CROPS						
LIVESTOCK						
PROBLEMS						
OPPORTUNITIES						

2. Transect Walk

A systematic walk with key knowledge holders through the community is used to visualize the interaction between the physical environment and human activities over space and time. Identify danger zones, evacuation sites, land use zones, etc.

1. Using a map, select a path that cuts through the community called a transect line. A transect line is one that cuts across something (can be more than one).
2. With a group of six to ten people who represent the cross-section, explain that the purpose of the exercise is to walk through the community and notice potential issues in a disaster.
3. Go on the walk with the group, taking time for observations and conducting brief and informal interviews with people you meet along the way at different places in the transect.

TOOL 8: At the Workshop

EXERCISE 3

Coping Strategies Analysis

EXERCISE 4

Folk Songs, Stories or Poetry

3. Coping Strategies Analysis

This exercise is used to understand livelihood strategies; behavior, decisions and perceptions around risk; and capacities and vulnerabilities of households from different socio-economic backgrounds.

1. Review the previously completed hazard map, seasonal calendar and capacity map from Tool 7 and determine criteria to select households belonging to different socio-economic groups (sample should not be at random).
2. Decide how many and which households in particular you will interview.
3. Conduct the interview (one hour); introduce yourself and the reason for the interview.
4. Start with getting to know household members' age and gender, followed by questions about livelihood and coping strategies.
5. Draw block or pie diagrams to facilitate discussions on livelihood sources.
6. Continue discussion on how the household copes in times of stress (material, social, spiritual).

4. Folk Songs, Stories or Poetry

This exercise asks the community if they have any traditional songs, stories, poems or sayings about disasters. These traditions can reveal indigenous knowledge, beliefs and practices.

Tool History: Developed and field-tested in Burundi, El Salvador, Philippines, Sri Lanka

References: Venton P and Hansford R (2006). *ROOTS 9: Reducing Risk of Disaster in Our Communities*, Tearfund.
Heijmans A and Victoria L (2001). *Citizenry-Based & Development-Oriented Disaster Response*, CDP.

NEXT STEPS: Tool 9: Prioritizing Activities (for stand-alone DRR activities)

Tool 16: Risk Reduction Programming (for integrating into development programs)

STORIES FROM THE FIELD

Comprehensive Mapping Exercise

by Daniella Flamenco



We were in five communities in Cuilapa, a medium-size village of about 3,000 people. We had a meeting with the local health promoters and the priest. I explained that I was testing the tool book and how to make the map with the tool book. I explained how the mapping had to be and I told the health promoters to make the map for the next visit. They asked me to write something as an example, so I drew a map.



CORE 3

DRR
Implementation

STANDARD 4

Risk Management
Plan



TOOL 9:

Prioritizing Activities

What is it?

A systematic process of prioritizing the DRR activities identified during the risk analysis (Tools 7 & 8).

Why use it?

In order to be most effective at minimizing the risk, it is important to prioritize the DRR activities.

How to use it?

1. Document the data from the mapping exercises in Tools 7 & 8, and distribute to the Committee members.
2. Arrange a meeting with the committee members to analyze the mapping data.
3. At the meeting, use the following language to introduce risk as a concept, “Risk is defined as the impact of hazards and vulnerabilities offset by the existing capacities.” Therefore:
 - The more intense or frequent the hazard, the **higher** the risk.
 - The greater the vulnerability, the **higher** the risk.
 - The greater the existing capacity, the **lower** the risk.The aim of a disaster risk reduction plan is to lessen the impact of hazards, reduce vulnerabilities and increase capacities, in order to mitigate and prepare for disasters.
4. Lead a group discussion with the committee to analyze the data from the hazard mapping exercises by asking the following questions. Document the responses.
 - What is the direct or indirect cause of the hazard?
 - What factors may influence the intensity or magnitude of the hazard?
 - How might we decrease the effects of the hazards faced by your community or parish?
5. Analyze the data from the vulnerability mapping exercises. Pose these questions to the committee for a group discussion. Document the responses.
 - Who is vulnerable? Consider age, gender, physical attributes, ethnicity, type of work, location of house/work/school, activities, familial relationships, memberships, etc.
 - What makes people vulnerable? Consider exposure to risks, lack of resources (familial or community support, financial, political, education, land and property, etc.)
 - When are people most vulnerable? Consider time of day, time of year, festivals, etc.
 - Where are people most vulnerable? Consider location (i.e., at home, in a displacement camp, outside the camp, after school, on the road, passing a nearby village, on public transport, at the market, etc.).
 - How might we reduce the vulnerability of people in your community or parish?

Tool History: Developed and field-tested in Burundi, El Salvador, Mozambique, Sri Lanka
References: Berry K (2010). *Safety with Dignity*, ActionAid.

TOOL 9: At the Workshop

6. **Analyze the data from the resource mapping exercises.** Pose these questions to the committee for a group discussion. Document the response.
 - What capacity do people currently have to absorb the shock themselves? Consider current coping strategies people are using to reduce their risk and what current capacities exist within the community (i.e., individual, collective, political, legal, health, financial, educational, transport, etc.).
 - What access do people have to resources that can help to reduce the impact of disasters?
 - What sort of resources can they access? Are they accessing them? Why or why not?
 - Is access to these resources safe, affordable and effective?
 - How might we increase the capacity within the community/parish?
 - How might we improve access to the resources the community has identified?
 - Which of these areas of the equation do we have the most control of? Which of these activities should we focus on?
7. **Close the discussion, using the following summary questions:**
 - How might we decrease the strength or frequency of the hazards faced by the community/parish?
 - How might we decrease the vulnerability of people in the community/parish?
 - How might we increase the capacities within the community/parish?
 - Which of these areas (hazards, vulnerabilities or capacities) does the community/parish have the most control of? Which of these activities should be the primary focus?
8. **A final exercise is to rank the various activities that have been identified.**
 - Make a diagram (pie chart or grid) or set up bowls that correspond to identified vulnerabilities in the community.
 - Give each individual six seeds (or stones or bottle caps) for them to allocate according to their priority.
 - Ask each individual to put three seeds on their first choice, two on their second choice and one on their third choice, based on the vulnerability that needs the most urgent attention.
 - If the committee wants the voting to be in secret, an alternative is to use paper bags to represent each vulnerability. Ask individuals to drop their seeds into the bag.

STEP 8 Vulnerability Ranking

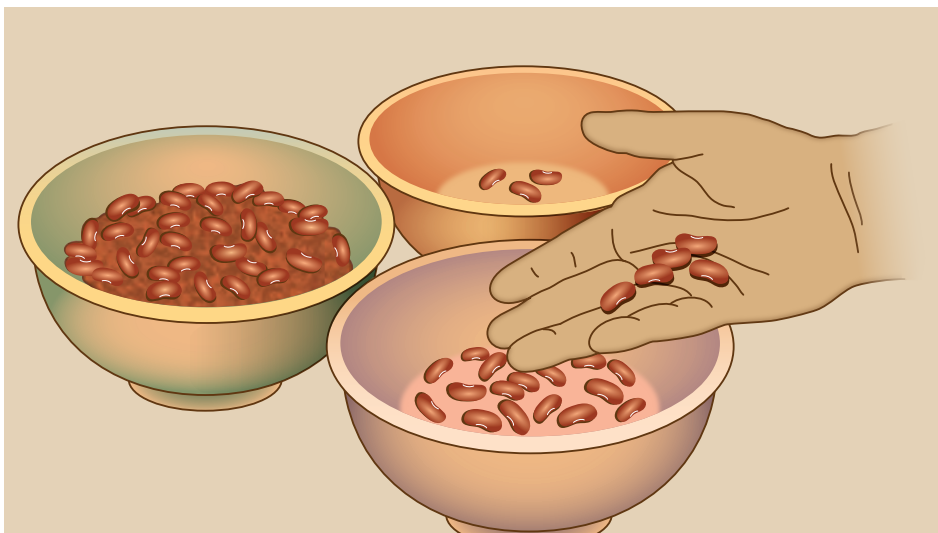

STORIES FROM THE FIELD

Needs Assessment in Burundi

by Leonidas Niyongabo



This is how we mapped the main needs in a community where most people are not literate. We met with all the villages outside under a tree. We asked the villagers what are the main disasters that we have in the area. They started to say, ***“We have drought, malaria, HIV, crop damage...”***

We brought with us 100 beans. We took those beans and we put them in a big pile on the ground in the middle of a circle of people.

We asked the people to divide the beans so that one pile represented HIV, a different pile represented malaria and likewise piles represented drought, crop damage, etc. The people understood immediately and made piles of beans that represented how significant each disaster was to them.

When they were done we had a lot of piles of beans! We counted the beans in each pile and we found that the pile of beans for **drought was the most, number two was malaria, third was crop disease**, etc.

I asked the community if they agreed. They agreed and were surprised with the results. This was our assessment experience.

CORE 3

DRR
Implementation

STANDARD 4

Risk Management
Plan



TOOL 10:

Early Warning System

What is it?

An Early Warning System provides the population with early warning of an impending hazard event.

Why use it?

Without early warning systems, there is potential for greater losses in lives, livestock, property and service infrastructure. Early warning systems activate the disaster management plans at household, community, parish and/or diocesan levels.

How to use it?

1. Assign one of the committee members to be responsible for early warning systems.
2. With the committee member, identify which other institutions are involved in early warning systems, and build relationships with these three levels of authority:

National Level

It is important to identify key institutions, such as a National Disaster Management Agency, which establishes national policy, or the National Meteorological Center, which will monitor progress on different hazards.

Regional Level

It is important to identify if there are sub-offices of the national agencies or if the regional government has additional departments to deal with disasters. In any case, it is important to take each government agency's arrangements into account.

Local Level

It is also important to identify sub-offices. For example, there may be additional mechanisms set up by the local government, such as search and rescue teams, etc. It is essential at this level to know the local arrangements put into place to assist community and parish populations during a disaster. The committee may choose to approach key people and offices to obtain this information, and register the contact details of both the committee member(s) and coordinator onto these networks/lists.



3. With the committee member, assist the parish/community in creating or enhancing its own early warning system, based on the type of hazard. Sample activities suggested are:
 - **Cyclones and hurricanes** – hand-held megaphones or signal flags are widely used.
 - **Floods** – volunteers may be deployed to monitor water levels during periods of heavy rain and then use bells or other loud noises to alert the community.
 - **Flash floods** – the warning system has to be fast and effective (i.e., church bells or mosque loudspeakers) because the community may have only minutes to respond.
 - **Drought** – conditions deteriorate slowly, but many drought-prone areas have a government or meteorological department warning system. Also, farmers often have their own traditional ways of forecasting drought (i.e., by interpreting insect behavior, wind directions or tree flowering patterns).
 - **Earthquakes** – scientific sources might be available, but more typically the community may need to interpret the signs of nature (i.e., any unusual behavior of cattle, dogs or birds).
 - **War and conflict** – church leadership and the news media are sources of information.
4. Propose to the committee to advocate with church leadership or write a grant proposal in order to secure funding for the implementation of the above activities.

Tool History: Developed and field-tested in El Salvador, Burundi, Sri Lanka

References: Venton P and Hansford R (2006). *ROOTS 9: Reducing Risk of Disaster in Our Communities*, Tearfund.

STORIES FROM THE FIELD

Risk Management Plans in El Salvador

by *Daniella Flamenco*



Salinas del Potrero has about 1000 people. The village suffers flooding every year. Many people are isolated and have to be evacuated with each flooding.

In the whole area, they only have one loudspeaker to let everyone know that there is danger. You cannot hear it in the farthest communities, which are the ones that are in the most danger of flooding from tsunamis that come from the Pacific.

We wanted to improve the early warning capabilities so we thought of walkie-talkie radios. This is how we tested it: I went with one of the staff to one of the communities and some community members went to the west and others went to the northeast. We were as spread out as possible – five miles from the farthest community, and it worked!

We decided to buy a pair of walkie-talkies for the rest of the communities. So the health promoters share one radio and two members of the community share the second walkie-talkie. We have a main person so when people from one community know that there will be a hazard that person will call the main person and she will call the other contacts, and they will advise the others. In that way people will have time to evacuate if there is a tsunami alert. This can also be for violence. If a violent group comes for someone or if there is an assault, the communities can be advised.

CORE 3

DRR
Implementation

STANDARD 4

Risk Management
Plan



TOOL 11:

Communication System

What is it?

A communication system to inform stakeholders of warnings or urgent needs. It is a mechanism to convey alerts that may have been identified through early warning devices or other sources of information.

Why use it?

There should be some system of communicating with church leadership, government officials and others to inform them of the particular needs of the affected community, and to reach out to those who may be isolated.

How to use it?

1. Make phone/email lists ahead of time.
2. Set up distribution lists before a disaster with up-to-date information. When a disaster strikes, there will not be time to compile these lists and still get your message out quickly and effectively. Include contacts to notify about relief services, such as government agencies, the diocese, local ecumenical partners, etc. Then when necessary, you can send out information immediately. Use and adapt this simple chart to meet your needs.

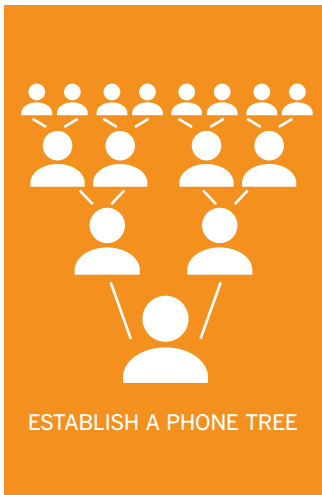

Title	Name Address	Main Phone/Alternate Phone Email
Diocesan Bishop		
DRR Coordinator		
DRR Committee Member #1		
DRR Committee Member #2		
Priest-in-Charge		
Parish Warden		
Parish Treasurer/Accountant		
Local Police Department		
Local Fire Department		
Ecumenical Contact #1		
Ecumenical Contact #2		

3. Establish a phone tree where, for example, the committee would inform two people, and each of those people would inform two other people, etc. Provide a copy of this list to all members.

Tool History: Developed and field-tested in El Salvador, India, Sri Lanka

CORE 3

DRR
Implementation

STANDARD 4

Risk Management
Plan



TOOL 12:

Evacuation Centers

What is it?

A community, parish or diocesan evacuation center ensures human safety during a disaster response.

Why use it?

A safe location that is easily accessible to all community members will reduce the vulnerability of those impacted by a disaster. This location must also have basic facilities to meet the immediate survival needs of the community.

How to use it?

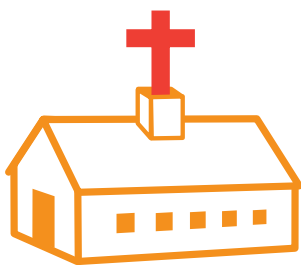

1. Identify a location (or several locations) for the evacuation center. In situations where people are forced to leave their homes, they may need to seek shelter with relatives or at a temporary building. The committee may choose to find such a building (i.e., a school or church on higher land, etc.).
2. Negotiate with the management of the identified building to strengthen roofs or walls to withstand a hazardous situation.
3. Each person in the community/parish should know of this location and the safest route to reach it.
4. The center should have adequate facilities, including safe drinking water supply and separate toilets for men and women, and it should meet cultural norms, have space for emergency amounts of dry food and blankets, and have areas for keeping livestock (if applicable).
5. Where there is no suitable building, open highland may be used. Advance preparation is required, both to remove unwanted vegetation and to bring in temporary shelter materials, such as plastic sheets and bamboo poles. Land use has also to be carefully planned, and arrangements made for water and latrines.
6. Identify leadership teams within the DRR Committee to address targeted activities, such as addressing thematic concerns (health, assisting the elderly, child welfare, etc.) or organizational concerns (networking with civil society, liaising with diocesan departments, disseminating early warning messages, etc.).
7. Network with civil society – in some situations, local NGOs or the government may have plans and resources to help the population cope with disaster (i.e., evacuation boats, radios and food stocks). The committee may choose to invite these organizations to their meetings, or visit them at their offices to establish good relationships with the relevant officials during non-disaster times and share information to avoid duplicating efforts or to coordinate a response.

Tool History: Developed and field-tested in China, El Salvador, Mozambique, Myanmar, Solomon Islands, South Sudan, Sri Lanka
References: Venton P and Hansford R (2006). *ROOTS 9: Reducing Risk of Disaster in Our Communities*, Tearfund.

CORE 3

DRR
Implementation

STANDARD 4

Risk Management
Plan



TOOL 13:

Community Drills

What is it?

A community, parish or diocesan evacuation plan ensures human safety during a disaster response.

Why use it?

Without continuous rehearsals and drills, an emergency evacuation can be chaotic, exhausting and ineffective.

How to use it?

1. Identify the location(s) of the evacuation area(s).
2. Identify leadership teams within the DRR committee to identify the safest route from various parts of the parish/community.
3. Each person in the parish/community should know of this location and the safest route to reach it.
4. Educate the community on the evacuation signal(s). Provide community members with information on the early warning system so that they understand it.
5. In societies where women cannot move freely without a male relative, widows or women with absent husbands may be at higher risk and need special plans for evacuation.
6. Disabled, elderly, ill or infirm people will need special attention, so make sure to pre-assign individuals to check on and accompany these particularly vulnerable people.
7. Because people learn best by doing things themselves, organize mock disaster situations and practice evacuations in safe conditions.

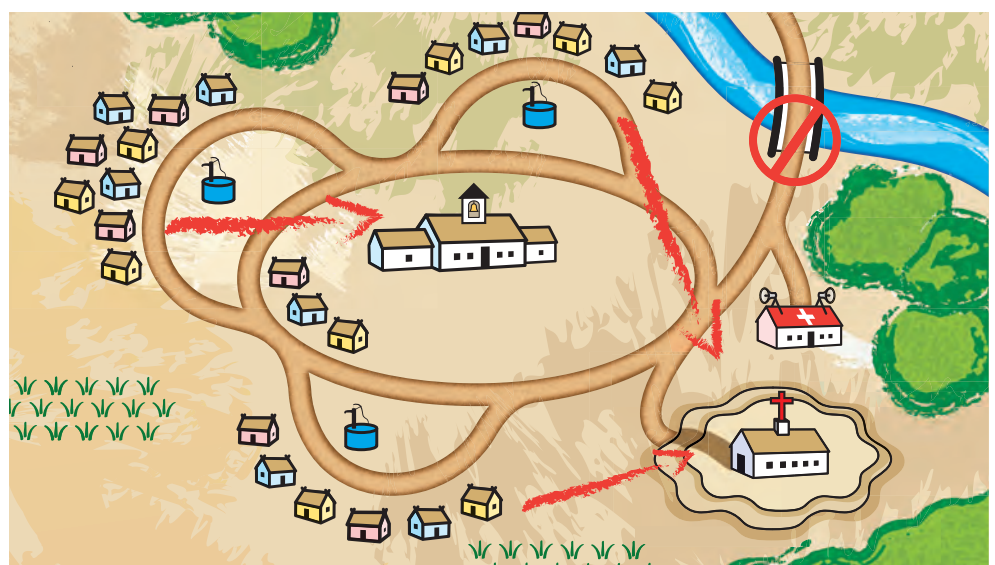

Tool History: Developed and field-tested in El Salvador, China, Mozambique, Sri Lanka

References: Venton P and Hansford R (2006). *ROOTS 9: Reducing Risk of Disaster in Our Communities*, Tearfund.

CORE 3

DRR
Implementation

STANDARD 4

Risk Management
Plan



TOOL 14:

Household Preparedness Kits

What is it?

A Household Preparedness Kit assists households in creating their own preparedness plan.

Why use it?

In high-risk areas, it is advisable for every household to have its own plan of what to do in an emergency, with every member fully aware of their own role.

How to use it?

1. Organize a parish/community training to share the following checklist.
2. Distribute this checklist and note that families can add more lines for family members and livestock.
3. Train the community on the importance of a disaster plan by going through each item in the checklist.
4. Keep the “emergency bag” in a safe and convenient location.
5. Ensure all family members know of the early warning signs and evacuation routes.
6. Arrange for a household meeting place in case family members get separated.
Provide special training to children and the more vulnerable members of the household.

HOUSEHOLD PREPARATION KIT



Tool History: Developed and field-tested in Burundi, El Salvador, Sri Lanka

References: Venton P and Hansford R (2006). *ROOTS 9: Reducing Risk of Disaster in Our Communities*, Tearfund.

TOOL 14: Household Preparedness Kits Checklist

List all members of your household

Are all household members safe and accounted for? Indicate with a checkmark (✓)

	()
	()
	()
	()
	()
	()
	()
	()

List all livestock

Is all livestock safe and accounted for? Indicate with a checkmark (✓)

	()
	()
	()
	()
	()
	()
	()
	()

Emergency Kit items

List all essentials.

Money:	()	Cooking utensils:	()
Documents:	()		()
	()		()
	()	Dry food:	()
Livelihood Tools:	()		()
	()		()
	()	Prescription medicine	()
Seeds:	()	Jewelry	()
	()	Change of clothing	()
Sanitary supplies	()	Flashlight and batteries	()
First Aid kit	()	Radio and batteries	()
Blankets/sleeping mats	()	Whistle	()

CORE 3

DRR
Implementation

STANDARD 4

Risk Management
Plan



TOOL 15:

Managing Volunteers

What is it?

A checklist for parishes or communities to mobilize and manage volunteers from outside the area who may be required in a major disaster.

Why use it?

In many disaster responses, the church responds best when it uses its strength in organizing volunteers from within the church membership. There are occasions when some communities or parishes will have the capacity to manage outside groups of volunteers to assist with the relief and recovery phases of a disaster response. Having a formal process to manage volunteers will make a disaster response more successful.

How to use it?

1. Determine if your parish/community is a good match for this type of volunteer ministry.
2. Establish a Volunteer Committee. Identify people from within the parish who can take charge of working with the volunteers. The committee should be able to answer questions related to logistics.
3. Designate the roles for the volunteer groups – coordination, procurement, relief distribution, transport, heavy labor, documentation, accounting, etc. Define the necessary activities.
4. Designate a watcher/security to assist in the monitoring of keys and building access.
5. Determine bathroom access for the volunteer groups.
6. Determine meals for the volunteer groups. If your church has a kitchen or pantry, could the volunteers use it? What do you need to acquire for the kitchen so that large groups can cook (pots, pans, cutting boards, soap, etc.).
7. Determine how parish property will be shared. Consider whether volunteers will be sharing the space with regularly scheduled groups, meetings or worship services.

Tool History: Developed and field-tested in Burundi, China, El Salvador, Myanmar, Sri Lanka

STORIES FROM THE FIELD

Volunteer Roles in South Sudan

by Joseph Loabe



We have a special system in South Sudan, through the Episcopal Church of South Sudan & Sudan (ECSSS). In our situation, we have trained the development coordinators to be emergency coordinators in each of the dioceses. In addition to the development coordinators, we also have volunteer teams of Mothers' Union members and other community members who actively participate in emergency responses.

The volunteers are responsible for the identification of vulnerable populations. The volunteer committee also is responsible for the distribution of the relief items as part of the capacity-building program of the diocesan DRR Committee.

The church staff holds a training and facilitation role, while the DRR Committee and the volunteer groups play implementation roles on the ground. During the crisis in December 2013, we followed this system quite successfully for the distribution of relief items to over 40,000 internally displaced persons.

CORE 3

DRR
Implementation

STANDARD 5

Risk Reduction
Integration



TOOL 16:

Risk Reduction Programming

What is it?

Recommendations for adding Disaster Risk Reduction activities into development programs.

Why use it?

Ongoing community development activities – and mainstreaming DRR activities into development efforts – can help communities become more resilient to disasters. In contrast, the benefits of development can be lost if disaster risk and climate change are not taken into account.

How to use it?

The following are a few examples by thematic area to illustrate the addition of activities to strengthen disaster resilience.

Water & Sanitation

- Build water taps and pipes higher than previous flood levels
- Monitor and maintain pipes in landslide areas to prevent leakage
- Clear storm drains, flood diversion channels and dikes to prevent damage to farms
- Provide alternative water sources for emergency situations or for flood-proofing existing water sources

Health Systems

- Assess land use to ensure appropriate location of health clinics
- Stockpile medicines necessary during seasonal floods or other water-related disasters
- Conduct training on health education to address disaster-related illnesses
- Conduct basic First Aid training

Agriculture

- Plant drought-resistant crop types or crop varieties, or employ alternative planting patterns
- Plant trees to stabilize slopes and promote erosion control and soil protection
- Plant trees to form shelter belts, or plant alternative crops that grow outside windstorm season
- Develop conservation farming methods or develop environmentally friendly farming technology
- Plant alternative crops or relocate crops, and plant flood-resistant varieties or change cropping patterns

Education

- Ensure that public buildings (schools, churches and hospitals) are earthquake resistant
- Improve designs of home or school buildings that are to be used as communal shelters
- Build flood-proof public sanitary facilities
- Train school children on disaster evacuation routes and facilitate mock drills

Tool History: Developed and field-tested in Burundi, El Salvador, China, Mozambique Myanmar, South Sudan, Solomon Islands, Sri Lanka

References: Asia Pacific Team (2012). *Disaster Risk Reduction Toolkit*, World Vision International.

Venton P and Hansford R (2006). *ROOTS 9: Reducing Risk of Disaster in Our Communities*, Tearfund.

CORE 3

DRR
Implementation

STANDARD 5

Risk Reduction
Integration



TOOL 17:

Disaster Risk Reduction Indicators

What is it?

Indicators measure progress towards goals.

Why use it?

Indicators are the verifiable benchmarks used to assess whether your program is on track to reach its goals and objectives.

How to use it?

The Capacity Assessment Worksheet (Section 4) provides a basis for measuring the change in the parish/community that is planning for the preparation and risk reduction process.

Program design usually involves both process and output indicators to measure activities, and outcome or result indicators to measure the change resulting from activities. Process indicators can be qualitative (attitudes, opinions or behavior), whereas output indicators are usually quantitative (numeric). Output indicators capture activities as they are completed whereas outcome or result indicators measure the broader impact of the plan.

Using output and outcome indicators ensures that the management of the DRR program is assessed, along with assessing whether the plan has the intended impact on the parish/community.

The short list shown here reflects some of the methods of measurement used to capture various levels of disaster risk reduction (at the organizational level and at the parish/community level). The list is organized by typical objectives. These are only suggested indicators. The committee is encouraged to choose indicators based on conversations with their local community.

OBJECTIVES & INDICATORS

1. Strengthen DRR capacity within the church structure

- Number of staff dedicated to DRR activities
- Establishment of a disaster response plan
- Number of staff trained in diocesan disaster plan
- Cost of relief activities
- Time between relief and rehabilitation

2. Strengthen DRR capacity within the community

- Number of community leaders training in disaster response
- Number of vulnerable population displaced
- Number of other organizations with which there are coordinated efforts
- Percent of time community requires outside help to assist in planning
- Number of incidences of social conflict within the community

Tool History: Developed and field-tested in China, Mozambique, Solomon Islands, Sri Lanka

CORE 4

Disaster
Response

STANDARD 6

Needs
Assessment



TOOL 18:

Relief Assessment Format

What is it?

A Rapid Needs Assessment provides the basis for developing a disaster response.

Why use it?

After a disaster has occurred, the parish may be the first group to respond. The committee will need a small team of people who can do a simple assessment of needs, skills and resources. This will help the committee to know the type of help needed and the quantity of goods or materials required. Any request for help to an outside source will require this information. It is important that this be completed with sensitivity. Leaders need training to explain why it is important to do surveys at the time of disasters instead of rushing in with relief items. They need to understand how this will help the community to cope and recover from the disaster in a more effective manner. It is also essential to tell the affected community the parameters (activities, timeline) of the response so that expectations are realistic.

How to use it?

1. Plan the assessment

- Read the checklists in the form below and adapt them if necessary.
- Agree on the ways of collecting information (interviews, group discussion, observations, discussion with other agencies).
- Assemble a small team. There should be a mix of male and female, and someone who can write down all the findings.

2. Meet groups affected by the disaster

- Try to meet as many groups affected by the disaster as possible, including the most vulnerable (women, children, elderly people, etc.) and marginalized groups (i.e., ethnic minorities).
- Find out needs with regard to food, shelter, water, sanitation and emotional support. Use the checklist below. Make sure data for men and women is recorded separately.

3. Get additional information from local officials

- If appropriate, visit local officials and assess available government relief stocks and plans for distribution (food, water, shelter materials).
- These officials should also have health data and information on medical facilities.
- Officials may also know which NGOs are working in which villages, and what resources are available.

4. Plan a response

- As a group, prioritize the main needs.
- Identify the resources available to meet these needs (from church, government, NGOs).
- Decide who will be responsible for different parts of the response.
- Decide where and when the response will start, and the order of different activities.

Tool History: Developed and field-tested in Burundi, China, Solomon Islands, South Sudan

References: Venton P and Hansford R (2006). ROOTS 9: *Reducing Risk of Disaster in Our Communities*, Tearfund.

NEXT STEP: Tool 20: Core Principles

TOOLS 5.41

TOOL 18: Relief Assessment Checklist

1 What is the total estimated number of people affected by this disaster?

Families _____
Children under five _____
Boys 6-14 years _____
Girls 6-14 years _____
Male adults _____
Female adults _____
TOTAL _____

2 Who are the most vulnerable?

Elderly _____
Disabled _____
Long-term sick _____
Pregnant mothers _____
Other _____
TOTAL _____

3 What are the most common injuries/ illnesses caused by the disaster?

4 Availability of food

How many families have no food? _____
Is there affordable food at local markets? _____
Are emergency supplies available? _____
Where? _____

5 Preparation of food

Do families have cooking utensils? _____
Is there fuel for cooking? _____
Are emergency supplies available? _____

6 Availability of water/toilets/sanitation

How many families are without water? _____
How many families are without toilets? _____
How far away is the nearest clean water? _____
How many need water containers? _____

7 Availability of immediate assistance

Are there groups who are completely cut off from assistance?

What kind of assistance is coming from government/ NGO sources or other churches, and who will benefit from the assistance?

What health facilities are available?

Is there risk of another disaster in the near future? (i.e., aftershock, flooding)

How has the disaster affected livelihoods and the ability to return to work? (i.e., farming, fishing)

How has the disaster affected the education system?

CORE 4

Disaster
Response

STANDARD 6

Needs
Assessment



TOOL 19:

Recovery Assessment Format

What is it?

A Recovery Needs Assessment provides the basis for developing a mid- to longer term response after the relief phase.

Why use it?

The committee will need a small team of people who can do a simple assessment of needs, skills and resources. Any request to an outside source for assistance will require this information. It is important that this be completed with sensitivity. Leaders need to be trained to explain why it is critical to do surveys at the time of disasters and how this will help the community to cope and recover from the disaster in a more effective manner. Instead of rushing in with relief items, it is essential to examine how existing assets and resources can be used to meet immediate needs, so as not to destroy or weaken possible resources and systems from within the community. It is also important to tell the affected community of the parameters (activities, timeline) of the response so that expectations are realistic.

How to use it?

1. Plan the assessment

- Read the checklists in the form below and adapt them if necessary.
- Agree on the ways of collecting information (interviews, group discussion, observations and discussions with other agencies).
- Mobilize a previously designated team or assemble a small team. There should be a mix of male and female, and someone who can write down all the findings.

2. Meet groups affected by the disaster

- Try to meet as many groups affected by the disaster as possible, including the most vulnerable (women, children, elderly people, etc.) and marginalized groups (i.e., ethnic minorities).
- Identify specific needs with regard to food, shelter, water, sanitation and emotional support. Record data for men and women separately.

3. Get additional information that may be available from local officials

- If appropriate, visit local officials and assess available government relief stocks and plans for distribution (food, water, shelter materials).
- These officials should also have health data and information on medical facilities.
- Officials may also know which NGOs are working in which villages, and what resources are available.

4. Cross-check information

- Organize a meeting of your assessors to share all the findings and cross-check for inconsistencies.
- If there are inconsistencies, seek additional information from new or existing sources before finalizing the needs assessment.

5. Plan a response

- As a group, prioritize the main needs.
- Identify the resources available to meet those needs (church, government, NGOs).
- Decide who will be responsible for different parts of the response.
- Decide where/when the response will start, and the order of different activities.

Tool History: Developed and field-tested in Burundi, China, Solomon Islands, South Sudan

References: Venton P and Hansford R (2006). ROOTS 9: *Reducing Risk of Disaster in Our Communities*, Tearfund.

NEXT STEP: Tool 20: Core Principles

TOOLS 5.43

TOOL 19: Recovery Assessment Checklist

1 What is the total estimated number of people affected by this disaster?

Families _____
Children under five _____
Boys 6-14 years _____
Girls 6-14 years _____
Male adults _____
Female adults _____
TOTAL _____

2 How many people have died?

Children under five _____
Boys 6-14 years _____
Girls 6-14 years _____
Male adults _____
Female adults _____
TOTAL _____

3 How many people are injured?

Children under five _____
Boys 6-14 years _____
Girls 6-14 years _____
Male adults _____
Female adults _____
TOTAL _____

4 Who are the most vulnerable?

Elderly _____
Disabled _____
Long-term sick _____
Pregnant mothers _____
Other _____
TOTAL _____

5 What are the most common injuries/illnesses caused by the disaster?

6 Damages to homes as a result of this disaster

How many have been partly damaged? _____
How many have been totally destroyed? _____

7 Availability of food

How many families have no food? _____
Is there affordable food at local markets? _____
Are emergency supplies available? _____
Where? _____

8 Availability of water/toilets/sanitation

How many families are without water? _____
How many families are without toilets? _____
How far away is the nearest clean water? _____
How many need water containers? _____

9 Availability of immediate assistance

Are there groups who are completely cut off from assistance?

What kind of assistance is coming from government/NGO sources or other churches, and who will benefit from the assistance?

What health facilities are available?

Is there risk of another disaster in the near future? (i.e., aftershock, flooding)

How has the disaster affected livelihood and the ability to return to work? (i.e., farming, fishing)

How has the disaster affected the education system?

STORIES FROM THE FIELD

Needs Assessment in Brazil

by Sandra Andrade



In Palmares, Brazil, a storm triggered the overflow of the River Una, and flooded at least eight neighborhoods leaving 12,000 people homeless.

The Anglican Diocese of Recife decided to help the victims of the flood and got together a committee of clergy and lay leaders. This is what we did:

- We found out what the damage was and spread the word about the disaster. We visited many areas to see the damage and wrote up a report about it. We also took photos and posted them on our website so that other organizations would know what the impact was.
- We registered families who were going to need help. Local churches helped us.
- We learned from the communities themselves what they needed and what kinds of services were already available.
- We identified gaps in shelter and food, and provided these items.

CORE 4

Disaster
Response

STANDARD 6

Relief
Activities



TOOL 20:

Core Principles

What is it?

Humanitarian organizations around the world have agreed on and established principles for disaster response activities.

Why use it?

These core principles are designed for fostering a response that is impartial and professional. Although Anglican churches and church agencies may not always be able to live up to global standards, they should still familiarize themselves with best practices.

How to use it?

The Red Cross & Red Crescent Societies and more than 400 NGOs share a common Humanitarian Code of Conduct, which guides decisions on how emergency funds are used. The Code of Conduct basically reflects Christian values of service for anyone who needs it, regardless of who they are or where they are located. We cannot choose certain groups to favor, such as church workers. We must serve others without asking for or expecting anything in return. Our attitudes should reflect the expertise and knowledge amongst those affected, as they are the most important contributors to a disaster response. This includes not publishing photos that show people as undignified and hopeless. Those who receive assistance should be involved in managing how aid is distributed.

Remember that the Bible is our Code of Conduct:

“There is no longer Jew or Greek, there is no longer slave or free, there is no longer male and female; for all of you are one in Christ Jesus.”

Galatians 3:28

It is important to be aware of these ten principles:

1. The humanitarian imperative comes first.
2. Give aid regardless of the race, creed, religion or nationality of the recipients and without discrimination of any kind. Calculate aid priorities on the basis of need alone.
3. Do not use aid to further a particular political or religious standpoint.
4. We shall endeavor not to act as instruments of government foreign policy.
5. We shall respect culture and custom.
6. We shall attempt to build disaster response on local capacities.
7. Find ways to involve program participants in the management of relief aid.
8. Relief aid must strive to reduce future vulnerabilities to disaster as well as meeting basic needs.
9. We hold ourselves accountable to both those we seek to assist and to those from whom we accept resources.
10. In our communication, publicity and advertising activities, we shall recognize disaster victims as dignified humans, not hopeless objects.

Tool History: Developed and field-tested in Burundi, China, El Salvador, Sri Lanka, South Sudan
References: The Sphere Project (2011). *The Sphere Handbook*.

NEXT STEP: Tool 21: Thematic Tip Sheets Tool 1: Serving the Wider Community

TOOLS 5.47

CORE 4

Disaster
Response

STANDARD 6

Relief
Activities



TOOL 21:

Thematic Tip Sheets

What is it?

Humanitarian organizations have set minimum standards for disaster response activities.

Why use it?

The minimum standards are general guidelines that meet the most urgent needs of an affected population. Any response should address these thematic needs.

How to use it?

The Sphere Project is a voluntary initiative that brings together a wide range of humanitarian agencies around common aims – to improve the quality of humanitarian assistance and the accountability of humanitarian actors to their constituents, donors and affected populations. *The Sphere Handbook* is one of the most widely known and internationally recognized sets of common principles and universal minimum standards in life-saving areas of humanitarian response. Its standards include:

1. People-Centered Humanitarian Response

People's capacity and strategies to survive with dignity are integral to the design and approach of humanitarian response.

2. Coordination and Collaboration

Humanitarian response is planned and implemented in coordination with the relevant authorities, humanitarian agencies and civil society organizations engaged in impartial humanitarian action, working together for maximum efficiency, coverage and effectiveness.

3. Assessment

The priority needs of disaster-affected populations are identified through a systematic assessment of the context and risks to life, balanced with dignity and the capacity of the affected people and relevant authorities to respond.

4. Design and Response

The humanitarian response meets the assessed needs of the disaster-affected population in relation to the context, the risks faced and the capacity of the affected people and state to cope and recover.

5. Performance, Transparency and Learning

The performance of humanitarian agencies is continually examined and communicated to stakeholders. Projects are adapted in response to performance.

6. Aid Worker Performance

Humanitarian agencies provide appropriate management, supervisory and psychosocial support, enabling aid workers to have the knowledge, skills, behavior and attitudes to plan and implement an effective and respectful humanitarian response.

We have simplified the Sphere Standards to meet the experience, understanding and reach of Anglican churches and church agencies. The Sphere Standards are not being replaced, but rather we have created three simplified thematic tip sheets that not only serve as tools for the Anglican context, but also serve as an initial step towards the long-term goal of meeting the more comprehensive Sphere Standards.

Tool History: Developed and field-tested in Burundi, China, El Salvador, Sri Lanka, South Sudan

References: The Sphere Project (2011). *The Sphere Handbook*.

Simplified Thematic Tip Sheets Based on Sphere Standards

1. Minimum standards in water supply, sanitation and hygiene promotion.
2. Minimum standards in food security and nutrition.
3. Minimum standards in shelter, settlement and non-food items

Tip Sheet #1

Water, Sanitation and Hygiene Promotion (WASH)

Maintaining clean water and keeping people and food clean is very important. Otherwise people get sick, and babies and elderly people may suffer and die. During times of disaster we must try extra hard to make sure people have clean water, and ways to keep clean and keep their food clean. There are guidelines to follow that most international organizations believe in and use about clean water, sanitation and hygiene, also known as WASH.

Water

One of the key principles that international communities follow is that *all people have safe equitable access to a sufficient quantity of water for drinking, cooking and personal and domestic hygiene. Public water points are sufficiently close to households to enable use of the minimum water requirements. Water is palatable and of sufficient quantity... without causing risk to health.*¹

- Consult women and men separately to identify the most appropriate timings for water distribution.
- People need 15 liters a day per person for drinking, cooking and washing. The water source should be no more than 500 meters from any household. Waiting time at a water source should not be more than 30 minutes.
- Implement all necessary steps to minimize water contamination and undertake water treatment where necessary. A key indicator is that there are no fecal coliform bacteria per 100ml of water at the point of delivery and use.

Excreta Disposal

One of the key actions to take to eliminate the risk of contaminating water and creating serious illness outbreaks is proper handling of human excreta. *The living environment in general and specifically the habitat, food production, public centers and surroundings of drinking water sources should be free from human fecal contamination. People should have adequate, appropriate and acceptable toilet facilities sufficiently close to their dwellings to allow rapid, safe and secure access at all times, day and night.*²

- Immediate action is taken to establish appropriate excreta containment steps. Communities should be educated immediately on safe excreta disposal and use of appropriate facilities.
- Latrines, pits, trenches and toilets should be 30 meters from water sources and the bottom of pits should be 1.5 meters above groundwater. Toilets must be designed in such a way to be safe for all people, including children and the disabled, and to minimize threats. The safety and privacy of women and girls

during the day and night are to be considered carefully when designing and placing toilets.

- Toilets should service no more than 20 people with separate, internally lockable toilets for men and women.

Tip Sheet #2

Food Security and Nutrition

One of the key principles that international NGOs follow is giving away free food when investigations have made it clear that it is necessary to provide free food to people who need it most. Giving away free food is stopped when people have recovered enough to produce or provide their own food. Some people – such as infants or the elderly – may need to have food provided longer than other people such as working adults.

*Ensure that the nutritional needs of the disaster-affected population, including those most at risk, are met and that food items provided are appropriate and acceptable to recipients so that they can be used efficiently and effectively at the household level.*³

This means that food is sufficient for what people need to remain healthy and that what's provided is the right kind of food. For instance, while everyone may like to drink a soda, such as Coca-Cola, that kind of food does not help people remain healthy. Key recommended actions include:

- Make sure that food is familiar to people and that they like it. Make sure that it has nutritional value and does no harm. Be aware that food that requires mixing with water or long cooking times should probably be avoided.
- Make sure that there is a safe place for storing the food and cooking it. This is both for health reasons and to avoid doing things that will cause environmental damage such as cooking food for a long time over firewood.
- Milk should never be distributed. This includes milk powder, formula, liquid milk or milk products. This is for serious health reasons.
- Remember nutritional requirements and use these as a way to think about what to provide to people: 2,100 kcals/person/day, 10 percent of total energy provided by protein, and 17 percent of total energy provided by fat.
- Remember to consider the elderly, people with HIV, people with disabilities and unaccompanied children when thinking about a population's food needs.

¹ The Sphere Project: Water Supply Standards 1 and 2

² The Sphere Project: Excreta Disposal Standards 1 and 2

³ The Sphere Project: Sphere Food Security–Food Transfer Standards 1 and 2

Shelter

When disasters or emergencies happen and people cannot live in their homes, many organizations provide some kind of shelter that will last a little or a long while. There is much to consider when providing shelters. Not only do they have to keep people safe and secure, but also they must not put women and children in vulnerable positions nor be bad for the environment. Prioritize women-headed households, as the female heads of households are more likely to be in poverty, live in unsuitable conditions and play multiple roles within the family.

Shelter and settlement strategies contribute to the security, safety, health and well-being of both displaced and non-displaced affected populations and promote recovery and reconstruction wherever possible. People should have sufficient covered living space that provides thermal comfort, fresh air and protection from the climate; ensures their privacy, safety and health; and enables their essential household livelihood.⁴

Key recommended actions include:

Types of Shelter Assistance

First figure out what people need. People may need things like personal items, such as clothing and bedding, cooking accessories, stoves and fuel. For very temporary situations, shelters can be tents or plastic

sheeting (remember to give people tools if plastic sheeting is used) or prefabricated materials. Cash can also be given so people can pay for shelter if it is available. If not all materials are provided, consider the impact on the environment if people are required to find missing materials, such as poles to hold up plastic sheeting.

Household and Livelihood Activities

The shelter should be covered enough to have space for the following activities: sleeping; washing; dressing; care of infants, children and elderly; and room for possessions. In rainy or cold climates, consider space for cooking and eating under the shelter.

Cultural Practices, Safety and Privacy

Make sure you are considering how families arrange for sleeping and taking care of personal needs. What space is needed in the shelter so women and others have a private place to dress and wash?

Participatory Design

It is highly recommended to ask the people who are going to use the shelters what they would like in a shelter, how they would use a shelter, what would make them feel safe and to have sufficient privacy. Mistakes are made when the people who are going to use the shelter are not asked for their ideas and needs.

⁴ The Sphere Project: Sphere Shelter and Settlement Standards 1 and 3

STORIES FROM THE FIELD

Relief Planning in Sri Lanka

by Hilary Wirasinha



Torrential monsoon rains struck Sri Lanka in late December 2010, causing major flooding. Some reports said it was the worst in over 100 years. More than one million people were affected. While relief efforts were aiding a shift into recovery, a second round of flooding occurred.

What did we do? Before we sent out help, we created a way to analyze the needs of the communities we decided we could assist. We asked for the following information from clergy and lay leaders of the parishes:

- Identification of area or community
- Rapid survey of the number of families and people affected
- Identification of requirements
- Identification of resources available (labor, food, transport)
- Period for which assistance is required
- Budget estimate

Altogether, about 1,800 families were assisted during this stage of our response.

Later, a team on an assessment mission visited all the affected areas, talked with people and did a survey of those affected by flood damage to shelters and livelihoods. The intent was for follow-up action. Finally, in March a sub-committee went again to look into the rehabilitation of damaged housing and livelihoods.

CORE 4

Disaster
Response

STANDARD 6

Relief
Activities



TOOL 22:

Risk Reduction in Disaster Relief & Recovery

What is it?

Guidelines on including disaster risk reduction activities in recovery and rehabilitation phases.

Why use it?

Including activities to reduce the impact of disasters while you are also working on response efforts will help a community to be better prepared for the next disaster.

How to use it?

When engaged in long-term recovery and rehabilitation activities (such as the construction of homes, establishing village health systems, repairing water sources, etc.) it is critical that the disaster risk of these activities be analyzed and addressed. Some guidelines for this process include:

1. Analyze the situation

Explore the role of hazards in the community and the related risk to recovery mechanisms.

2. Set long-term recovery objectives

Determine whether and how to build disaster risk management into key long-term objectives.

3. Prioritize public action for long-term recovery

Consider actions to reduce the vulnerability to hazards in designing a recovery plan.

4. Establish monitoring and evaluation procedures

Include disaster risk management in long-term targets and indicators as relevant. In particular, capture the impacts of related initiatives on the affected population and on reduced vulnerability rather than reduced losses.

5. Implement, evaluate and get feedback

Review disaster risk management achievements and shortcomings, including the adequacy of initial disaster risk analysis.

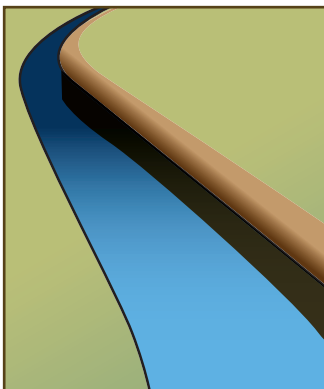
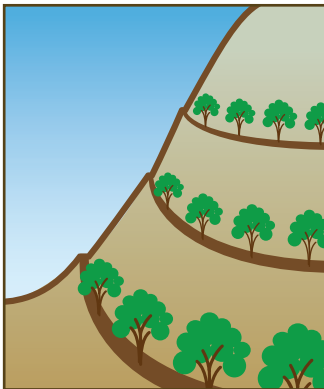

Some examples of DRR activities, filtered by hazard include:

Floods

- Elevate food and water storage
- Improve house designs and church buildings commonly used as shelters
- Plant trees, especially on slopes and embankments
- Conduct training on how to improve farming skills and deal with flooding
- Develop a planting calendar
- Develop infrastructure for preventing hazards (i.e., dams, dikes, etc.)

Landslides

- Dig storm drains to carry away rainwater from slopes
- Build low walls along the contour of the slope
- Avoid cutting into slopes for construction and avoid landslide-prone areas for water infrastructure and piping
- Use leak proof, waterproof elements and materials in landslide areas

Tool History: Developed and field-tested in Burundi, China, El Salvador, Philippines, Sri Lanka

References: Venton P and Hansford R (2006). *ROOTS 9: Reducing Risk of Disaster in Our Communities*, Tearfund.

NEXT STEP: Capacity Assessment Worksheet (For re-assessing capacity)

TOOLS 5.53

TOOL 22: At the Workshop

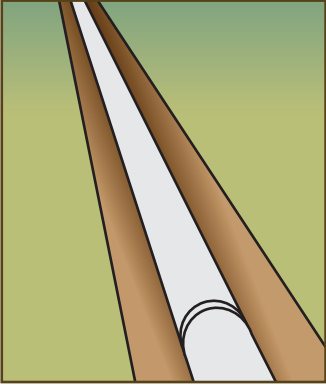

Windstorms

- Use improved methods of house construction, especially for roofs and windows
- Plant trees to form shelter belts or crops that grow outside windstorm season
- Dig and regularly clean storm drains
- Build typhoon/wind-safe water infrastructure (pipelines, reservoirs, wells, latrines)

Earthquakes

- Build new houses according to earthquake-resistant designs; use lightweight roof materials
- Reinforce existing buildings to give extra strength
- Avoid building on hillsides or in landslide-prone areas
- Provide earthquake-resistant farming technology, for example earthquake-resistant drainage systems and reinforced earth methods for slope and retaining walls
- Build earthquake-resistant storage facilities and livestock shelters

Drought

- Construct small-scale irrigation schemes with foot- or animal-powered pumps
- Plant drought-resistant crop types or crop varieties, or employ alternative patterns
- Develop water retention pond systems
- Improve land use techniques for agriculture and livestock
- Develop natural reservoir systems

Conflict

- Maintain an impartial church and be visible in advocacy and peace-building efforts
- Develop relationships with shops and companies to ensure multiple supply routes
- Train peace and reconciliation committees in targeted areas

STORIES FROM THE FIELD

Myanmar Cyclone Response

by U San Lin



In 2008, a deadly cyclone rushed towards the Myanmar delta, devastating the lives of people in many towns and villages. Our Church gathered volunteers, and in order to find out how they could bring relief to those affected, set off towards the delta where a number of parishioners had suffered.

The work that we did over the next two years really made a difference to those villagers. We provided more than 200 houses for parishioners and people not from our parish who had lost everything in the cyclone. We adopted those villages and provided integrated services

One woman said, *"We've lived in bamboo and thatch huts all our lives. Never in our dreams had we ever imagined that we would live in a wooden house like this. Thank you."*

We also looked at the water problem, and helped with the provision of three 5,000-gallon water tanks. We built the water tanks strong enough to withstand future storms. Then we thought, how are people going to make a living when they have lost so much? So we helped with fishery livelihood efforts, such as the distribution of boats and nets. We facilitated shared ownership of the boats to ensure that community systems were strengthened. We also built houses, but used stronger materials and raised them to withstand future flooding. We also rebuilt our churches in the area with stronger foundations and ceiling beams, so that they could be used as evacuation shelters.

CORE 4

Disaster
Response

STANDARD 8

Staff Care



TOOL 23:

Staff Care Policy

What is it?

A checklist to establish an endorsed policy to care for staff and priests involved in relief work.

Why use it?

To share the burden of coordinating, facilitating and implementing a response, it is important to make sure that there is sufficient support and resources for clergy and staff tasked with this responsibility.

How to use it?

After disasters, the role of the church in facilitating a response and serving the community is endless. Whether meeting immediate food and water needs, assisting with clothing and shelter, helping people wrestle with questions about why such events occur or, in the long-term, supporting emotional and spiritual recovery, such assistance does not come without a price. In many contexts, clergy in major disaster areas experience very high turnover following disasters. First, clergy rightly perceive serving those in need as their calling, but too often, clergy take on the role of “Superman,” overextending themselves physically, emotionally and spiritually. The outcome ranges from exhaustion, burnout and loss of personal faith – impairing their ability to continue supporting affected people or their congregations – to conflicts with their congregations, marital or family problems, substance abuse and even suicide.

Guidelines for Establishing a Staff Care Policy

1. Meet with your bishop or archbishop to offer some background on the need for a policy.
2. Ensure that relief committees are formed following a disaster to share the responsibilities.
3. Set aside regular times for meeting with staff and dedicated volunteers to allow for the delegation of tasks.
4. Make time for Sabbath: daily, weekly, monthly and annually.
5. Ensure that priests and staff prioritize personal social relationships to maintain a balance.
6. Identify church human resources to provide pastoral counseling (retired priests or bishops).
7. Identify professional resources for psychosocial counseling and establish a budget.
8. Establish guidelines for regular “check-ins” with priests and staff by a spiritual counselor.
9. Establish guidelines on regular opportunities for priests and staff to have access to pastoral or professional counseling.

Tool History: Developed and field-tested in: El Salvador, Solomon Islands, Sri Lanka

TOOL 24: At the Workshop

Have the group make a list of the causes and symptoms of stress. Write all of the responses on large paper. Ask volunteers to share an example of how they have used a coping tool, or to identify where they could use a technique in their current context.

Physical Reactions	extended fatigue, physical complaints, headaches, sleep disturbance, appetite changes
Emotional Reactions	anxiety, feeling alienated from others, desire to be alone, negativism/cynicism, suspiciousness/paranoia, depression/chronic sadness, feeling pressured, overwhelmed, diminished pleasure, loss of sense of humor
Thinking Reactions	tired of thinking, obsessive thinking, difficulty concentrating, increased distractibility, inattention, problems with decisions/priorities, feeling indispensable, obsessions, diminished tolerance for ambiguity, constricted thought, rigid/inflexible thinking
Acting or Behaving Reactions	irritability, anger displacement/blaming others, reluctance to start or finish tasks
Spiritual/Philosophical Reactions	doubt of value system/religious beliefs, questioning the major life areas (profession, employment, lifestyle), feeling threatened and victimized, disillusionment, self-preoccupation

CORE 4

Disaster
Response

STANDARD 8

Staff Care



TOOL 24:

Recognizing and Managing Stress

What is it?

An exercise to recognize stress in ourselves and our co-workers, and to cultivate skills and coping mechanisms for managing stress.

Why use it?

Stress brought about by disasters makes people's lives even more challenging than they already are. Stress affects us physically, emotionally and socially, making it hard to focus on the things we need to do. While we are often amazed by the adaptability and resilience of people and relief workers who are responding to disasters, everyone needs extra help managing stress in times of disaster.

It is useful for planners at the diocesan/central level to recognize the build-up of stress and tension, and to factor staff and self care into their planning. It is equally important for relief workers and volunteers to feel 'appreciated,' 'recognized' and 'commended' for their dedication and hard work, and appropriately acknowledged.

How to use it?

Follow these steps to identify signs of stress in yourself or others, and identify specific techniques that can help in managing the stress. This exercise can be done in a group, such as the DRR Committee.

Discussion for the Workshop

1. What is stress?

Explain: Some experts say that stress is the balance between what you have to do and the resources you have to do it. We may experience stress when we feel we do not have enough time, money, energy, ideas, people or support to do the things that need to be done. Stress can also be described as a normal physical response to events that feel threatening or upset the normal balance of things in some way.

2. What are some of the things you see or notice when you or someone else is stressed?

Explain: There is no shame in feeling stressed. Especially in times of emergencies we are going to be stressed and we can help each other. Stress affects us at many levels: Physical, Emotional, Rational (thought processes), Behavioral and Spiritual. Go over the list you have made and identify which of these are represented in the list.

Examples: Being impatient; easily angered; unable to sleep; sleeping too much; drinking too much; withdrawing from significant relationship; pessimism, etc.

3. What are some ideas on how to better manage stress or to help someone going through a period of stress?

Explain: There is nothing shameful or negative for any of us to find that we are stressed. Especially in times of emergencies we are going to be stressed and we can help each other. Identify with the group some ideas for managing stress.

Examples: Talk to a friend/pastor/supervisor to share feelings and pray together; take time off for physical recreation (i.e., football, volleyball, cricket or other exercise); listen to soothing music; practice relaxing techniques (i.e., yoga, meditation and breathing exercises; go for walks to calm soothing places (i.e., beach, mountain path).

TOOL 24: At the Workshop

17 Things You Can Do To Manage Stress

1. **Avoid or limit time with people who cause additional stress.**
2. **Manage your environment.** If the news makes you anxious, try to avoid listening or engaging in political discussions.
3. **Make a priority list.** Write down things that **MUST** be done on top and the less important things further down, and follow the list.
4. **Express feelings instead of bottling them up.** If something or someone is bothering you, communicate your concerns in an open and respectful way.
5. **Be willing to compromise.** When you ask someone to change their behavior, be willing to do the same. If you both are willing to bend at least a little, you'll have a good chance of finding a happy middle ground.
6. **Adjust your standards.** Don't try to always be perfect in what you do, specifically in a disaster situation. Set yourself reasonable standards.
7. **Exercise.** Go for a slow walk. Stretch or do a few exercise moves such as jumping jacks in place or yoga moves.
8. **Focus on the positive.** Take a moment to reflect on all the things you appreciate in your life. At the end of each day, write down three things that went well that day.
9. **Don't try to control the uncontrollable.** Many things in life are beyond our control – particularly the behavior of other people. Focus on the things you can control. For instance, how you choose to react to situations and problems.
10. **Learn to forgive.** Accept the fact that we live in an imperfect world and that people make mistakes. Let go of anger and resentments. Free yourself from negative energy by forgiving and moving on.
11. **Connect with others.** Spend time with positive people who enhance your life.
12. **Set aside prayer or meditation time.** Even five minutes a day to meditate or pray will help bring calmness into your sense of well-being.
13. **Keep your sense of humor.** This includes the ability to laugh at yourself and at situations. Laughter helps reduce stress and improves overall health.
14. **Eat a healthy diet.**
15. **Reduce caffeine (tea/coffee) and sugar intake.**
16. **Avoid alcohol, cigarettes, and drugs.**
17. **Get enough sleep.** Adequate sleep fuels your mind, as well as your body. Feeling tired will increase your stress because it may cause you to think irrationally.

Conclude the activity by asking everyone to share one thing they can do to reduce their stress, and one thing they can do to help someone else to manage their stress. You can also identify how the group might work together on stress reduction strategies.

The United Nations High Commission for Refugees deals with high levels of stress every day and here is what they say:

"Identify and support vulnerable team members who may suddenly show multiple signs of stress. Be prepared to provide prompt assistance in the form of a break with immediate support, brief rest and refreshment, a chance to talk about what is bothering the person."

SECTION 6:

Case Studies

Case Study #1: Procurement of Food Supplies

Episcopal Church of South Sudan & Sudan and SUDRA



The Church of South Sudan & Sudan illustrates the strength of the Church with its long history of mobilizing volunteers and church resources to support vulnerable people in times of emergency, by developing risk reduction systems for responding to a humanitarian crisis.

Following the approval of the Emergency Crisis Committee at the Provincial Level, the Church supervised procurement of food supplies. A bidding advert was placed in newspapers. Out of a receipt of 20 bids, a short list of three vendors was selected. Price was the main determining factor, although other considerations included the ability of the vendor to make immediate delivery, SUDRA's (the provincial level relief department's) previous history with the vendor and whether or not the vendor could provide multiple items. The committee then visited the three vendors to ensure quality of the products, quality of the delivery vehicles and the overall viability of the operation.

Finally a vendor was selected and SUDRA developed a contract that included stipulations for the replacement of any items that were found to be unsuitable. The contract stipulated that half the agreed payment would be provided on pick-up of the shipment and the other half on the safe delivery of the items. The contract also stipulated the vehicle owner's liability for lost or damaged items where the loss or damage was the result of the vehicle owner's negligence.

At time of the delivery, and prior to loading the shipment headed for Awerial, SUDRA staff spot-checked at least five percent of the food items for quality and signs of damage or infestation, as well as ensuring that the expiration date of each bag was later than the end of the project. We did not have any problems, although our procedures indicated that any problematic items would be replaced immediately and if a significant portion of spot-checked items were found to be unsuitable, the contract would be cancelled and another vendor will be selected from among those who had already submitted bids. SUDRA staff accompanied the shipment to Awerial.

Once we arrived in Awerial, the goods were offloaded under the supervision of the local Diocese of Awerial team. The team supervised the counting of all items and compared it with the documentation at the time of loading in Juba.

Once off-loaded, the items were stored inside church property in a place with concrete floors. Access to these store-rooms was controlled by the Diocesan Emergency Coordinator. Since the Awerial response included cooking the food in nine different locations, some of the items were immediately distributed to a site supervisor, who was generally a Mothers' Union leader.

The Mothers' Union mobilized teams to prepare, cook and distribute the food at all nine locations. The cooked food was prepared to provide approximately half a child's required food intake – 644 calories. It was determined that most children were able to access one meal per day from other sources and should have been able to acquire the remainder of their nutritional requirements from other sources, such as friends or volunteer caregivers, extended family or from other feeding programs.

The diocesan teams, along with members from the IDP community, selected the 3,000 participants on the basis of need and vulnerability with priority given to children who arrived in Awerial without any parents or guardians, primarily to children under age 5. As there were additional rations available, children with a single parent were added from youngest to oldest.

The diocesan teams worked with the provincial staff at SUDRA to prepare this report.

Case Study #2:

A Church Accompanying its People During Armed Conflict in El Salvador

Episcopal Anglican Diocese of El Salvador



El Salvador was engaged in a de facto civil war from 1980-1992 between the government, Armed Forces of El Salvador and the insurgent forces of the Farabundo Marti National Liberation Front (FMLN). During this long 12-year period, an estimated 75,000 persons were reported dead or missing. The armed conflict ended after a process of dialogue between the parties, with the signing of peace accords on January 16, 1992, between the Government of El Salvador and the FMLN in the Castle of Chapultepec, Mexico.

The root cause of the war was mainly social inequality. During the 1970s, El Salvador was gripped by popular apathy. The lack of freedom and the growing gap between rich and poor (10% of the population enjoyed 80% of the country's wealth) contributed to overall tensions. The prevalent feeling was that people had no present or future – I shared that sentiment.

Although the entire population felt voiceless, helpless and marginalized, the nation's historic Churches united with a collective voice. This was also the role of our Episcopal Church of El Salvador – we stood in solidarity with the suffering of the people.

The Lutheran, Roman Catholic, Emmanuel Evangelical Baptist and Episcopal churches joined together under the name Diakonia to join forces and be a witness to the Good News of Jesus to a people without hope. We formed a social movement.

During the 12 years of conflict, Diakonia met in secret in the now famous 'Green Room' in San Juan Evangelista, an Episcopal church. We met every week to discuss the possible protest locations and advocacy initiatives with international governments, and to strategize how best to communicate the realities faced by the population at large in El Salvador. We also visited government leaders in the USA, Canada, Australia and several countries in Europe.

Diakonia also engaged in relief distribution. Starting in 1987, some Salvadoran refugees began to return home under the protection of the United Nations Refugee Agency, UNHCR. Of course, Diakonia also sought economic resources to help thousands of families who had lost their husbands or sons (the main wage earner) in the conflict.

Despite challenges, we were undeterred in our mission. Diakonia remained able to meet in the church premises to plan on how best to distribute food, clothes and other relief items to thousands of families. This presence and witness of the Church attracted the attention of the National Police, who suspected that the aid was for the guerrillas. As many of those we served were affiliated with the insurgents, the government wrongly labeled us Diakonia Frente (FMLN).

This suspicion by the armed forces resulted in the arrest of my colleagues and myself. Without trial, we were transferred to a secret police prison where I was questioned for several days until I was transferred to the national Mariona Prison as political prisoner. This was on November 17, 1988, just days after the murder of the Jesuits of the Universidad Centroamericana (UCA).

Thanks to the intervention of The Episcopal Church and the Governments of Spain, Mexico and UK, we all got freedom on January 6, 1990.

The Rev. Luis Serrano

Case Study #3: The Church at Work in a Human-Made Disaster

Diocese of Colombo, Church of Ceylon



How does the church act when caught up in the midst of an armed conflict between the state and a rebel group?

The long-going armed conflict between militant Tamil group LTTE and the Sri Lankan state came to a bloody end in the North of the country in 2009. During the final stages of the war almost 300,000 people, virtually the entire population of two districts in the North, were uprooted from their homes and were housed in a complex of temporary IDP (Internally Displaced Persons) camps from February to December 2009.

The Anglican Diocese of Colombo, which has had a strong presence in the North, played the role of a “wounded healer” during this extremely stressful period. Some clergy, who were also personally affected by the conflict, continued to minister to the spiritual, security and physical needs of the IDPs. Local residents, including entire congregations of our churches in the region, were caught up between the advancing Army and the retreating militant group. Finally they escaped the combat areas only to find themselves incarcerated for about a year within the IDP camp, with very limited freedom of movement and restricted access to external support, including clergy.

This situation led to one of the largest disaster relief and rehabilitation efforts ever undertaken by the diocese – surpassed only by the Indian Ocean tsunami response of 2004-05. However, in this case, there was the added complication of the post-war situation, with difficulties travelling, accessing the war-affected areas, and contacting the IDPs.

Initially the Church, working alone or networking with other churches or NGOs, provided emergency relief, as the situation allowed, in the form of medical supplies, clothing, bedding, supplementary food items and cash grants, as well as making solidarity visits to hospitals and IDP camps.

The Church’s involvement deepened with time with the opening of a relief coordinating center close to the IDP village called the “Community of Witness,” which became the focal point for volunteer workers travelling from other parts of the country, a meeting place for discussions and reflection and a place of worship for IDPs.

The diocese continued to accompany the people as they gradually returned to their war-torn places of residence, providing temporary shelters, livelihood assistance and educational support for children.

For those who were involved in this work it was a humbling and enriching experience to see the resilience, solidarity and deep faith of these people amidst their suffering. As the resettlement process advanced, it was indeed a joy to witness the land springing back to life from the ashes of war, and to see people beginning to look with hope toward a better future for them and their children.

References

- Abarquez I and Murshed Z (2004). *Field Practitioner's Handbook*, Asian Disaster Preparedness Center.
- Anderson M (1999). *Do No Harm: How Aid Can Support Peace or War*, Lynne Rienner Publishing.
- Asia Pacific Team (2012). *Disaster Risk Reduction Toolkit*, World Vision International.
- Bainbridge D, Macpherson S and Marshall M (2007). *Good Practice Guide to Gender Sensitivity*, Tearfund.
- Blackman R and Carter I (2010). *ROOTS 13: Environmental Sustainability*, Tearfund.
- Berry K (2010). *Safety with Dignity*, ActionAid.
- Care International (2010). *Emergency Toolkit*.
- Carter I (2004). *Mobilizing the church: A PILLARS Guide*, Tearfund.
- Carter I (2003). *Mobilizing the community: A PILLARS Guide*, Tearfund.
- Carter I (2002). *Preparing for disaster: A PILLARS Guide*, Tearfund.
- Curtis D (2001). *Politics of Humanitarian Aid: Debates, Dilemmas and Dissension*, Overseas Development Institute.
- Dulhunty A (2008). *The Protection Toolkit*, Australian NGO Mainstreaming Protection Project.
- Inter-Agency Standing Committee (2007). *IASC Guidelines on Mental Health and Psychosocial Support in Emergency Settings*, IASC.
- Inter-Agency Standing Committee (2006). *Women, Girls, Boys and Men: Different Needs – Equal Opportunities*, IASC.
- Hansford, B (2006). *Disasters and the Local Church*, Tearfund.
- Heijmans A and Victoria L (2001). *Citizenry-Based & Development-Oriented Disaster Response*, CDP.
- Terry F (2002). *Condemned to Repeat/ The Paradox of Humanitarian Action*, Cornell University.
- The Sphere Project (2011). *The Sphere Handbook*.
- Training Course Materials (2005). *Community Based Disaster Risk Management*, ADPC.
- Turnbull M, Sterrett C and Hilleboe A (2013). *Toward Resilience*, ECB Project.
- Twigg J (2010). *Characteristics of a disaster-resilient community*, Eldis.
- Venton P and Hansford R (2006). *ROOTS 9: Reducing risk of disaster in our communities*, Tearfund..
- Venton P and La Trobe S (2008). *Linking climate change adaptation and disaster risk reduction*, Tearfund.
- United Nations International Strategy for Disaster Reduction (2009). *Terminology on disaster risk reduction*.
- United Nations International Strategy for Disaster Reduction (2012). *Towards a Post-2015 Framework for Disaster Risk Reduction*.
- United Nations Development Program (2004). *Reducing Disaster Risk, A Challenge for Development*.
- US Disaster Program (2011). *Preparedness Planning Guide*, Episcopal Relief & Development.
- Wisner B, Blaikie P, Cannon T and Davis I (2003). *At Risk: natural hazards, people's vulnerabilities and disasters*, Routledge.

Additional Resource Toolkits

- Protection: Training Guide and Toolkit, Australian NGO Mainstreaming Protection Project.
- Women, Girls, Boys and Men: Different Needs – Equal Opportunities, IASC.
- Disasters and the Local Church, Tearfund.
- Reducing Risk of Disaster in our Communities, Tearfund.

Episcopal Relief & Development
815 Second Avenue, New York, NY 10017
855.312.HEAL (4325) episcopalrelief.org
info@episcopalrelief.org



EpiscopalRelief